



MedLED[®] Chrome

Truly Cordless[™]

Stirnleuchten
Headlights



Denken, fühlen, modulare Beleuchtung...
unermüdliches Licht für das Leben!

Think, feel, modular illumination...
relentless light for life!

MedLED® Chrome Stirnleuchten Headlights

Freiheit ohne Kompromisse

Die MedLED®-Chrome-Stirnleuchte verfügt über die modernste Lichttechnologie, und erreicht so, was früher unmöglich war: eine Stirnleuchte, die jedes beliebige OP-Feld ausleuchten kann, sowohl in Bezug auf Lichtintensität als auch Spotgröße, und dabei lautlos, komfortabel und kabellos ist.

Merkmale

- Lichtintensität:
 - MC3 – 100.000 lux
 - MC6 – 200.000 lux
 - MC7 PRO – 275.000 lux – jetzt noch heller
- Akkulaufzeit:
 - MC3 – 7,75 Std.
 - MC6 – 6,75 Std.
 - MC7 PRO – 3,50 Std.
- Gewicht (inkl. Batterien)
 - MC3 – 335 g
 - MC6 – 335 g
 - MC7 PRO – 350 g
- Akkulaufzeit: siehe oben, abhängig vom Modell; praktisch unbeschränkt dank Ladegerät mit 4 Ladeschächten
- USB-Ladedauer: 6,5 Stunden
- Ladedauer im 4-Schacht-Ladegerät: 10 Stunden; gleichzeitiges Aufladen von bis zu zwei Sets
- Justierung: volle Einstellbarkeit des Strahlwinkels, Links-Rechts-schwenkbar, größerer Spotgrößenbereich
- Spot-Qualität: scharf abgegrenzter, kreisförmiger Strahl mit homogenem Licht

Freedom without sacrifice

The MedLED® Chrome headlight has incorporated the best that technology offers to accomplish the once impossible; a headlight that can light up any field in the O.R. in terms of both intensity and spot size and is silent, comfortable, and cordless.

Features

- Luminous intensity:
 - MC3 – 100,000 lux
 - MC6 – 200,000 lux
 - MC7 PRO – 275,000 lux – now even brighter
- Battery service life:
 - MC3 – 7.75 hr
 - MC6 – 6.75 hr
 - MC7 PRO – 3.50 hr
- Weight (incl. batteries)
 - MC3 – 335 g
 - MC6 – 335 g
 - MC7 PRO – 350 g
- Battery service life: see above, depends on model; infinite with 4-bay charger
- USB charging time: 6.5 hours
- 4-Bay charging time: 10 hours; charge up to two sets at a time
- Adjustability: full beam angle adjustability, left-to-right swivel, increased spot size range
- Spot quality: crisp, circular beam of homogenous light

MedLED® Chrome

Freiheit ohne Kompromisse

Wenn Sie eine leistungsfähige, langlebige, komfortable Stirnleuchte ohne Kabel suchen, kann Ihnen KLS Martin ein vollständiges Sortiment an Stirnleuchten mit passendem Zubehör anbieten.

Freedom without sacrifice

If you have a need for a powerful, long lasting, comfortable headlight with no cord, KLS Martin is able to offer you a full range of headlights and accessories.



Intensität und Helligkeit Power and Brightness

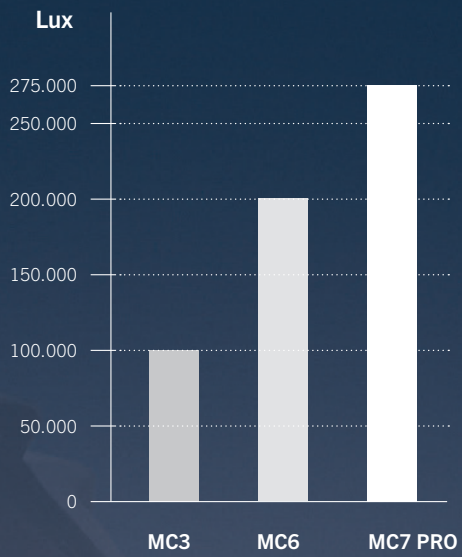

200 mm
MC7 PRO

maximum spot diameter range
Maßstab/scale 1:1

100 mm
MC3

90 mm
MC6

MedLED® Chrome

Integrierte Schaltkreise

Dies ist unsere Leitlinie.
Keine Gürteltasche, keine Kabel, keine Probleme,
sondern wirklich kabelloser Betrieb.
Licht ohne Kompromisse!

Keine Beeinträchtigung der Sterilität.
Ohne Kabel oder Akkupack am Gürtel.

Head-mounted circuit technology

That's our mission statement.
No cables, no hassles. Lose the optical cables
and belt pack cords and go cordless without
sacrificing basic operating light needs.

Does not interfere with sterility.
Without cables or battery belt packs,
it's kept safely above the neck.



Quiet-Cool™ Kühlkörper-Technologie

Kühl und leise

Um unnötiges Erwärmen zu vermeiden, wird die LED mithilfe einer firmeneigenen Technologie sofort gekühlt. Wir haben außerdem das Gehäuse so gestaltet, dass es mögliche Restwärme selbst ableitet.

Lüfter brauchen mehr Strom und dadurch große Akkus, die an der Taille des Benutzers befestigt werden müssen. Hiermit gehören die Lüfter der Vergangenheit an.

Quiet-Cool™ Heatsink technology

Cool and quiet

Proprietary technology is used to cool the LED instantly, avoiding the potential for unnecessary heat buildup. We also designed the housing itself to manage any remaining thermal dissipation.

Fans also demand more power, requiring large batteries attached to the waist of the user.

Einstellbarkeit und Steuerung des Spots Spot Adjustability and Control

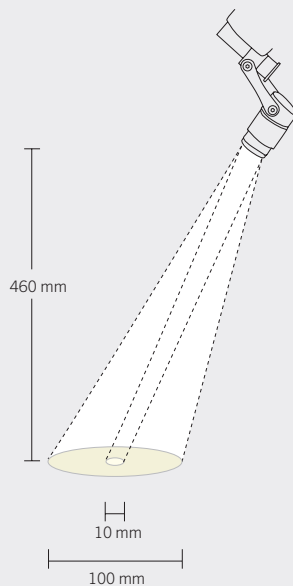

MC3

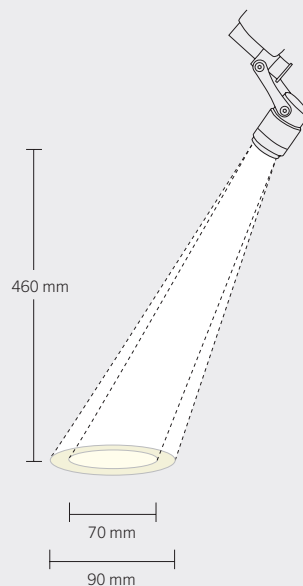

MC6

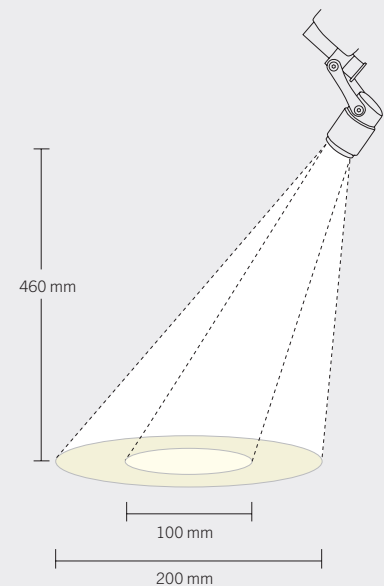

MC7 PRO



MedLED® Chrome Stirnleuchten/Headlights – Hardtop Ready to use!

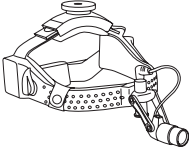

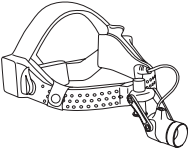
	MedLED® Chrome MC3 – Hardtop	Item No.
	bestehend aus: Stirnleuchte MedLED® Chrome MC3 (Hardtop), Transportkoffer, USB-Ladekabel, Netzteil inkl. Adapter EU, US, UK, AU und 2 Akkus (Lithium-Polymer)	17-500-40-04
	consisting of: headlight MedLED® Chrome MC3 (hardtop), carrying case, USB charging cable, PSU incl. adapter for EU, US, UK, AU and 2 rechargeable lithium-polymer batteries	

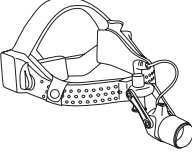
	MedLED® Chrome MC6 – Hardtop	Item No.
	bestehend aus: Stirnleuchte MedLED® Chrome MC6 (Hardtop), Transportkoffer, USB-Ladekabel, Netzteil inkl. Adapter EU, US, UK, AU und 2 Akkus (Lithium-Polymer)	17-500-50-04
	consisting of: headlight MedLED® Chrome MC6 (hardtop), carrying case, USB charging cable, PSU incl. adapter for EU, US, UK, AU and 2 rechargeable lithium-polymer batteries	

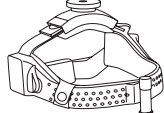
	MedLED® Chrome MC7 PRO – Hardtop	Item No.
	bestehend aus: Stirnleuchte MedLED® Chrome MC7 PRO (Hardtop), Transportkoffer, USB-Ladekabel, Netzteil inkl. Adapter EU, US, UK, AU und 2 Akkus (Lithium-Polymer)	17-500-60-04
	consisting of: headlight MedLED® Chrome MC7 PRO (hardtop), carrying case, USB charging cable, PSU incl. adapter for EU, US, UK, AU and 2 rechargeable lithium-polymer batteries	

	MedLED® Chrome MC3/6/7 PRO – Hardtop	Item No.
 	bestehend aus: Stirnleuchte MedLED® Chrome MC3, MC6, MC7 PRO (Hardtop), Transportkoffer, USB-Ladekabel, Netzteil inkl. Adapter EU, US, UK, AU und 2 Akkus (Lithium-Polymer)	17-500-70-04
	consisting of: headlight MedLED® Chrome MC3, MC6, MC7 PRO (hardtop), carrying case, USB charging cable, PSU incl. adapter for EU, US, UK, AU and 2 rechargeable lithium-polymer batteries	

MedLED® Chrome

Stirnleuchten/Headlights – Softtop Ready to use!

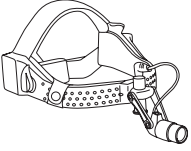
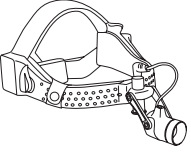
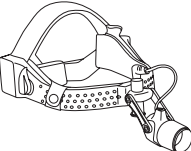
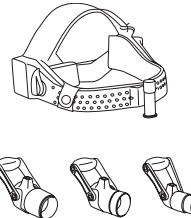

	<table border="1"> <thead> <tr> <th data-bbox="371 792 1273 831">MedLED® Chrome MC3 – Softtop</th> <th data-bbox="1273 792 1433 831">Item No.</th> </tr> </thead> <tbody> <tr> <td data-bbox="371 831 1273 947"> <p>bestehend aus:</p> <p>Stirnleuchte MedLED® Chrome MC3 (Softtop), Transportkoffer, USB-Ladekabel, Netzteil inkl. Adapter EU, US, UK, AU und 2 Akkus (Lithium-Polymer)</p> </td> <td data-bbox="1273 831 1433 947" rowspan="2">17-500-42-04</td> </tr> <tr> <td data-bbox="371 947 1273 1064"> <p>consisting of:</p> <p>headlight MedLED® Chrome MC3 (softtop), carrying case, USB charging cable, PSU incl. adapter for EU, US, UK, AU and 2 rechargeable lithium-polymer batteries</p> </td> </tr> </tbody> </table>	MedLED® Chrome MC3 – Softtop	Item No.	<p>bestehend aus:</p> <p>Stirnleuchte MedLED® Chrome MC3 (Softtop), Transportkoffer, USB-Ladekabel, Netzteil inkl. Adapter EU, US, UK, AU und 2 Akkus (Lithium-Polymer)</p>	17-500-42-04	<p>consisting of:</p> <p>headlight MedLED® Chrome MC3 (softtop), carrying case, USB charging cable, PSU incl. adapter for EU, US, UK, AU and 2 rechargeable lithium-polymer batteries</p>
MedLED® Chrome MC3 – Softtop	Item No.					
<p>bestehend aus:</p> <p>Stirnleuchte MedLED® Chrome MC3 (Softtop), Transportkoffer, USB-Ladekabel, Netzteil inkl. Adapter EU, US, UK, AU und 2 Akkus (Lithium-Polymer)</p>	17-500-42-04					
<p>consisting of:</p> <p>headlight MedLED® Chrome MC3 (softtop), carrying case, USB charging cable, PSU incl. adapter for EU, US, UK, AU and 2 rechargeable lithium-polymer batteries</p>						
	<table border="1"> <thead> <tr> <th data-bbox="371 1131 1273 1169">MedLED® Chrome MC6 – Softtop</th> <th data-bbox="1273 1131 1433 1169">Item No.</th> </tr> </thead> <tbody> <tr> <td data-bbox="371 1169 1273 1285"> <p>bestehend aus:</p> <p>Stirnleuchte MedLED® Chrome MC6 (Softtop), Transportkoffer, USB-Ladekabel, Netzteil inkl. Adapter EU, US, UK, AU und 2 Akkus (Lithium-Polymer)</p> </td> <td data-bbox="1273 1169 1433 1285" rowspan="2">17-500-52-04</td> </tr> <tr> <td data-bbox="371 1285 1273 1402"> <p>consisting of:</p> <p>headlight MedLED® Chrome MC6 (softtop), carrying case, USB charging cable, PSU incl. adapter for EU, US, UK, AU and 2 rechargeable lithium-polymer batteries</p> </td> </tr> </tbody> </table>	MedLED® Chrome MC6 – Softtop	Item No.	<p>bestehend aus:</p> <p>Stirnleuchte MedLED® Chrome MC6 (Softtop), Transportkoffer, USB-Ladekabel, Netzteil inkl. Adapter EU, US, UK, AU und 2 Akkus (Lithium-Polymer)</p>	17-500-52-04	<p>consisting of:</p> <p>headlight MedLED® Chrome MC6 (softtop), carrying case, USB charging cable, PSU incl. adapter for EU, US, UK, AU and 2 rechargeable lithium-polymer batteries</p>
MedLED® Chrome MC6 – Softtop	Item No.					
<p>bestehend aus:</p> <p>Stirnleuchte MedLED® Chrome MC6 (Softtop), Transportkoffer, USB-Ladekabel, Netzteil inkl. Adapter EU, US, UK, AU und 2 Akkus (Lithium-Polymer)</p>	17-500-52-04					
<p>consisting of:</p> <p>headlight MedLED® Chrome MC6 (softtop), carrying case, USB charging cable, PSU incl. adapter for EU, US, UK, AU and 2 rechargeable lithium-polymer batteries</p>						
	<table border="1"> <thead> <tr> <th data-bbox="371 1469 1273 1507">MedLED® Chrome MC7 PRO – Softtop</th> <th data-bbox="1273 1469 1433 1507">Item No.</th> </tr> </thead> <tbody> <tr> <td data-bbox="371 1507 1273 1624"> <p>bestehend aus:</p> <p>Stirnleuchte MedLED® Chrome MC7 PRO (Softtop), Transportkoffer, USB-Ladekabel, Netzteil inkl. Adapter EU, US, UK, AU und 2 Akkus (Lithium-Polymer)</p> </td> <td data-bbox="1273 1507 1433 1624" rowspan="2">17-500-62-04</td> </tr> <tr> <td data-bbox="371 1624 1273 1740"> <p>consisting of:</p> <p>headlight MedLED® Chrome MC7 PRO (softtop), carrying case, USB charging cable, PSU incl. adapter for EU, US, UK, AU and 2 rechargeable lithium-polymer batteries</p> </td> </tr> </tbody> </table>	MedLED® Chrome MC7 PRO – Softtop	Item No.	<p>bestehend aus:</p> <p>Stirnleuchte MedLED® Chrome MC7 PRO (Softtop), Transportkoffer, USB-Ladekabel, Netzteil inkl. Adapter EU, US, UK, AU und 2 Akkus (Lithium-Polymer)</p>	17-500-62-04	<p>consisting of:</p> <p>headlight MedLED® Chrome MC7 PRO (softtop), carrying case, USB charging cable, PSU incl. adapter for EU, US, UK, AU and 2 rechargeable lithium-polymer batteries</p>
MedLED® Chrome MC7 PRO – Softtop	Item No.					
<p>bestehend aus:</p> <p>Stirnleuchte MedLED® Chrome MC7 PRO (Softtop), Transportkoffer, USB-Ladekabel, Netzteil inkl. Adapter EU, US, UK, AU und 2 Akkus (Lithium-Polymer)</p>	17-500-62-04					
<p>consisting of:</p> <p>headlight MedLED® Chrome MC7 PRO (softtop), carrying case, USB charging cable, PSU incl. adapter for EU, US, UK, AU and 2 rechargeable lithium-polymer batteries</p>						
	<table border="1"> <thead> <tr> <th data-bbox="371 1807 1273 1845">MedLED® Chrome MC3/6/7 PRO – Softtop</th> <th data-bbox="1273 1807 1433 1845">Item No.</th> </tr> </thead> <tbody> <tr> <td data-bbox="371 1845 1273 1962"> <p>bestehend aus:</p> <p>Stirnleuchte MedLED® Chrome MC3, MC6, MC7 PRO (Softtop), Transportkoffer, USB-Ladekabel, Netzteil inkl. Adapter EU, US, UK, AU und 2 Akkus (Lithium-Polymer)</p> </td> <td data-bbox="1273 1845 1433 1962" rowspan="2">17-500-72-04</td> </tr> <tr> <td data-bbox="371 1962 1273 2078"> <p>consisting of:</p> <p>headlight MedLED® Chrome MC3, MC6, MC7 PRO (softtop), carrying case, USB charging cable, PSU incl. adapter for EU, US, UK, AU and 2 rechargeable lithium-polymer batteries</p> </td> </tr> </tbody> </table>	MedLED® Chrome MC3/6/7 PRO – Softtop	Item No.	<p>bestehend aus:</p> <p>Stirnleuchte MedLED® Chrome MC3, MC6, MC7 PRO (Softtop), Transportkoffer, USB-Ladekabel, Netzteil inkl. Adapter EU, US, UK, AU und 2 Akkus (Lithium-Polymer)</p>	17-500-72-04	<p>consisting of:</p> <p>headlight MedLED® Chrome MC3, MC6, MC7 PRO (softtop), carrying case, USB charging cable, PSU incl. adapter for EU, US, UK, AU and 2 rechargeable lithium-polymer batteries</p>
MedLED® Chrome MC3/6/7 PRO – Softtop	Item No.					
<p>bestehend aus:</p> <p>Stirnleuchte MedLED® Chrome MC3, MC6, MC7 PRO (Softtop), Transportkoffer, USB-Ladekabel, Netzteil inkl. Adapter EU, US, UK, AU und 2 Akkus (Lithium-Polymer)</p>	17-500-72-04					
<p>consisting of:</p> <p>headlight MedLED® Chrome MC3, MC6, MC7 PRO (softtop), carrying case, USB charging cable, PSU incl. adapter for EU, US, UK, AU and 2 rechargeable lithium-polymer batteries</p>						

MedLED® Chrome Zubehör/Accessories

Vergrößerungslinsen MC3 Magnifier lenses MC3

Vergrößerung Magnification	Dioptrien	Vergrößerung	Erhöhung der Sehstärke	Optische Leistung	Empfohlener Arbeits- abstand (Brennweite)	Art.-Nr.
	Diopter	Magnification	Increase in eyesight	Optical power	Recommended working distance (focal length)	Item No.
	+ 2	+ 0.40	40 %	1.4 x	250 mm	17-500-12-04
	+ 3	+ 0.60	60 %	1.6 x	220 mm	17-500-13-04
	+ 4	+ 0.80	80 %	1.8 x	200 mm	17-500-14-04

Vergrößerungslinsen MC6 / MC7 PRO Magnifier lenses MC6 / MC7 PRO

Vergrößerung Magnification	Dioptrien	Vergrößerung	Erhöhung der Sehstärke	Optische Leistung	Empfohlener Arbeits- abstand (Brennweite)	Art.-Nr.
	Diopter	Magnification	Increase in eyesight	Optical power	Recommended working distance (focal length)	Item No.
	+ 2	+ 0.40	40 %	1.4 x	250 mm	17-500-22-04
	+ 3	+ 0.60	60 %	1.6 x	220 mm	17-500-23-04
	+ 4	+ 0.80	80 %	1.8 x	200 mm	17-500-24-04

Ladegerät Desktop charger

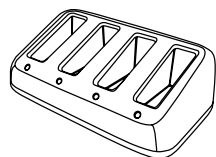

17-500-17-04

Ersatzakkus (2 St.) Spare batteries, rechargeable (2 pcs.)

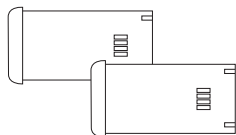

17-500-21-04

Koffer Carrying case

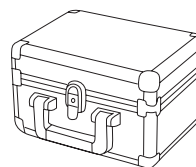

17-500-29-04

MedLED® Chrome

Zubehör/Accessories

Ersatzstirnbänder Spare head bands

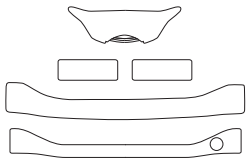

17-500-36-04
Neoprene Comfort Velcro
für/for Hardtop

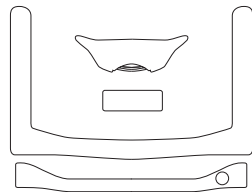

17-500-37-04
Neoprene Comfort Velcro
für/for Softtop

Gesichtsschutz Face shield

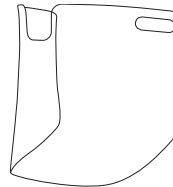

17-500-30-04
Gesichtsschutz zur Verwendung mit MedLED®-Stirnleuchten
Face shield for adapting to the MedLED® headlights

GoPro Adapter

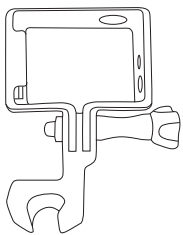

17-500-31-04

Ersatzkopfband Spare headstrap

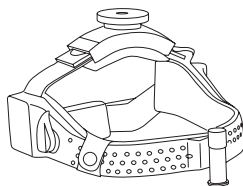

17-500-32-04
Hardtop

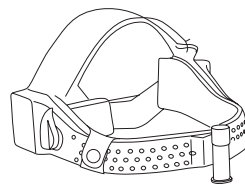

17-500-33-04
Softtop

Gelbfilter (für Dental) Amber filter (for Dental)



17-500-34-04
MC3



17-500-35-04
MC6

Leuchtkörper Bezel

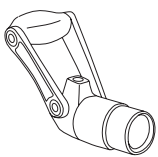

17-500-41-04
MC3

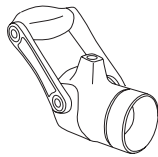

17-500-51-04
MC6

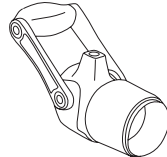

17-500-61-04
MC7 PRO

Ladegerät/Netzstecker Desktop charger/Mains plug

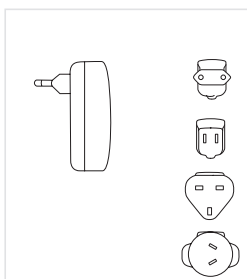

Art.-Nr. / Item No.	
EU	17-500-01-04
US	17-500-02-04
UK	17-500-03-04
AU	17-500-04-04

USB-Kabel (allein) USB cable (only)

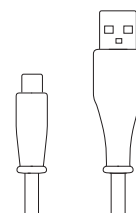

17-500-19-04

KLS Martin Group

KLS Martin Australia Pty Ltd.

Sydney · Australia
Tel. +61 2 9439 5316
australia@klsmartin.com

KLS Martin do Brasil Ltda.

São Paulo · Brazil
Tel. +55 11 3554 2299
brazil@klsmartin.com

KLS Martin Medical (Shanghai)

International Trading Co., Ltd
Shanghai · China
Tel. +86 21 5820 6251
info@klsmartin.com

KLS Martin India Pvt Ltd.

Chennai · India
Tel. +91 44 66 442 300
india@klsmartin.com

KLS Martin Italia S.r.l.

Milan · Italy
Tel. +39 039 605 67 31
info@klsmartin.com

KLS Martin Japan K.K.

Tokyo · Japan
Tel. +81 3 3814 1431
info@klsmartin.com

KLS Martin SE Asia Sdn. Bhd.

Penang · Malaysia
Tel. +604 261 7060
malaysia@klsmartin.com

KLS Martin de México, S.A. de C.V.

Mexico City · Mexico
Tel. +52 55 7572 0944
mexico@klsmartin.com

KLS Martin Nederland B.V.

Huizen · Netherlands
Tel. +31 35 523 45 38
infonl@klsmartin.com

KLS Martin SE & Co. KG

Moscow · Russia
Tel. +7 499 792 76 19
russia@klsmartin.com

KLS Martin Taiwan Ltd.

Taipei · Taiwan
Tel. +886 2 2325 3169
taiwan@klsmartin.com

KLS Martin SE & Co. KG

Dubai · United Arab Emirates
Tel. +971 4 454 16 55
middleeast@klsmartin.com

KLS Martin UK Ltd.

Reading · United Kingdom
Tel. +44 118 467 1500
info.uk@klsmartin.com

KLS Martin LP

Jacksonville · Florida, USA
Tel. +1 904 641 77 46
usa@klsmartin.com

KLS Martin SE Asia Sdn. Bhd.

Hanoi · Vietnam
Tel. +49 7461 706-0
info@klsmartin.com

KLS Martin SE & Co. KG

A company of the KLS Martin Group

KLS Martin Platz 1 · 78532 Tuttlingen · Germany
P.O. Box 60 · 78501 Tuttlingen · Germany
Tel. +49 7461 706-0 · Fax +49 7461 706-193
info@klsmartin.com · www.klsmartin.com