

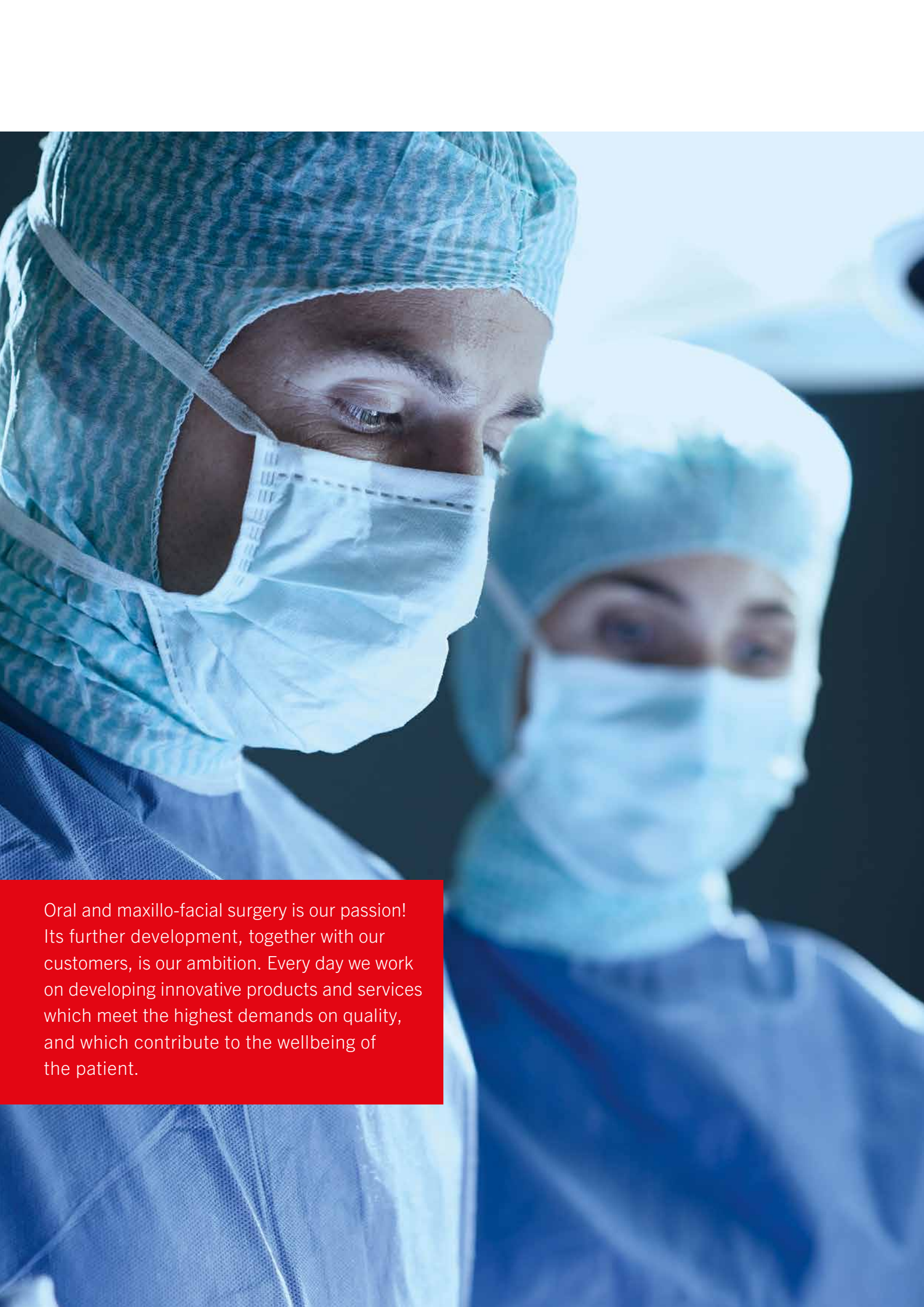

Arnett FAB

Orthognathic System

Designed in cooperation with
Dr. William Arnett, Santa Barbara, CA



Oral and maxillo-facial surgery is our passion! Its further development, together with our customers, is our ambition. Every day we work on developing innovative products and services which meet the highest demands on quality, and which contribute to the wellbeing of the patient.

FAB – face, airway, bite

The goals of Orthognathic Surgery are facial, airway, and bite correction (FAB). The Arnett FAB Orthognathic System has been developed based on 35 years of surgical experience. The plates, screws, and instrumentation are designed to improve surgical accuracy and stability.

Benefits

- Enables surgical movements necessary for facial balance, airway and bite correction
- Plates designed to place screws into the thickest bone with minimal bending
- A system of instruments, plates, and screws to improve surgery outcomes
- Plates designed to decrease unnecessary bending
- All plates designed for strength across osteotomies
- No empty screw holes span osteotomy sites

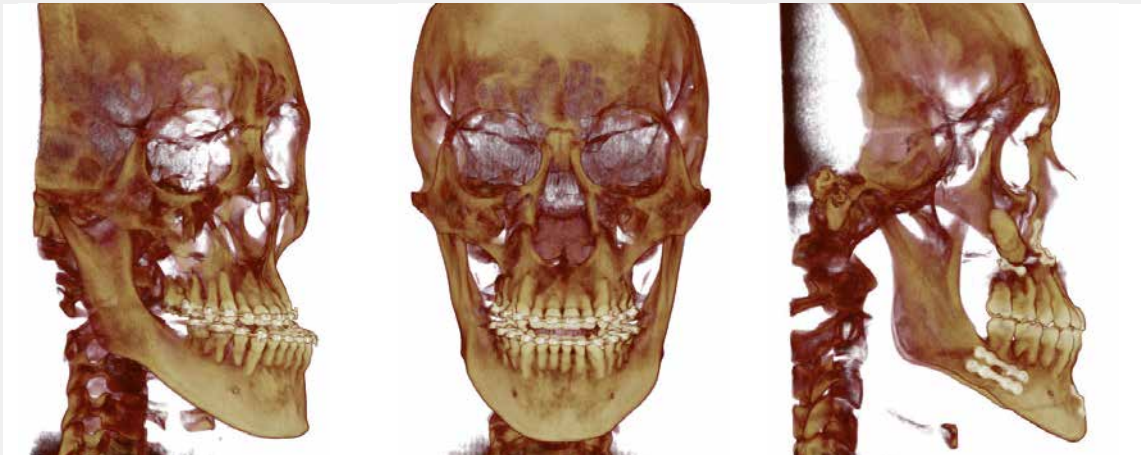
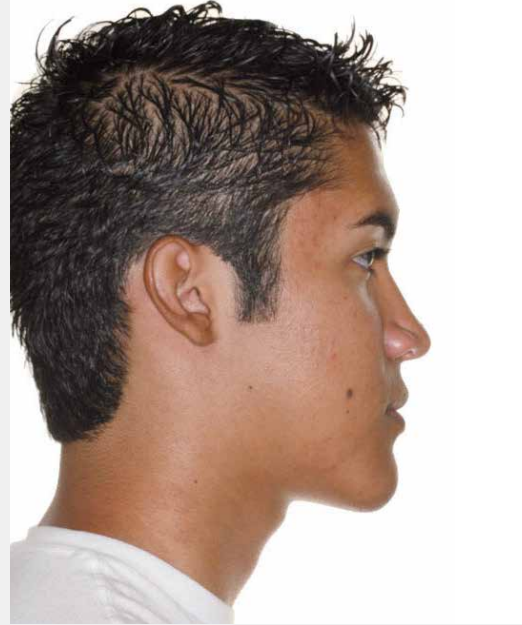
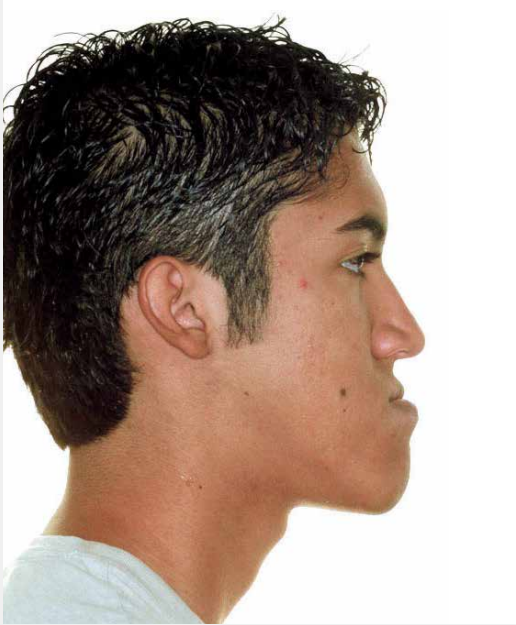



St

Stainless steel

1

Quantity / units per package

55-961-32-04

Arnett FAB Module

with lid and inserts (without contents)

- All plates are reversible – can be used on left or right side
- All plates have carry tabs to allow direct placement on the bone for passive fitting
- C plates – designed to place screws in the thick piriform rim bone
- L plates – designed to place screws in the thickest piriform or zygomatic buttress bone
- T plates – designed for multisegment Le Fort I osteotomies between the canine and bicuspid teeth
- Sagittal osteotomy plates – designed for intraoral placement to avoid condylar torque
- In-place benders allow final bends after two screws are attached to bone

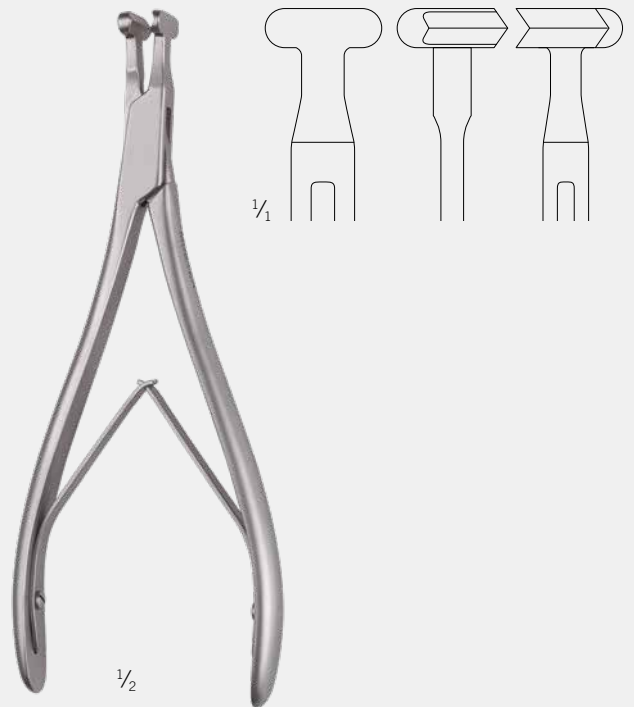

25-439-19-07

18.5 cm / 7 1/4"

BSSO in-place hammer head bender

St 1



Plate profile



Titanium



Aluminum



Quantity / units per package



Sterile packed implants



Template

Midface

Anatomically designed for maxillary advancement

- Plates are pre-shaped to follow the anatomy of zygomatic buttress and piriform rim.
- Allows for screw placement where bone is thickest.
- Multiple plate sizes allow for a variety of advancements.
- Plate tabs facilitate plate bending, try in, perfect fit to bone, and screw placement.

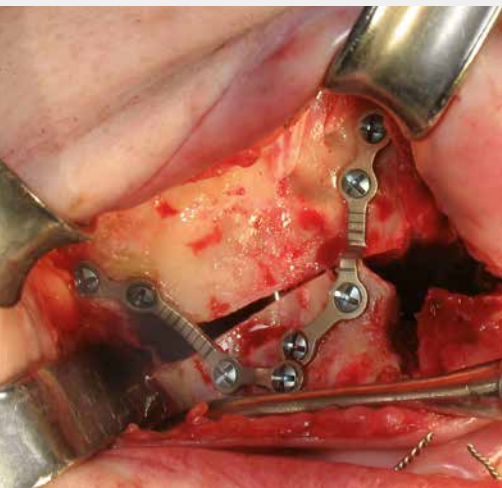

L plates – for piriform rim and zygomatic buttress placement



1/1

25-397-27-09 **Ti** 1

25-397-27-71 **Ti** 1

Mini plate, 4-hole, L-shape, small, w/tab

⌀ = 0.8 mm

25-397-27-89 **Al** 1



25-397-31-09 **Ti** 1

25-397-31-71 **Ti** 1

Mini plate, 4-hole, L-shape, medium, w/tab

⌀ = 0.8 mm

25-397-31-89 **Al** 1



25-397-35-09 **Ti** 1

25-397-35-71 **Ti** 1

Mini plate, 4-hole, L-shape, large, w/tab

⌀ = 0.8 mm

25-397-35-89 **Al** 1

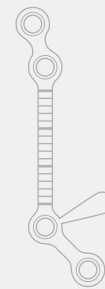

25-397-39-09 **Ti** 1

25-397-39-71 **Ti** 1

Mini plate, 4-hole, L-shape, extra large, w/tab

⌀ = 1.0 mm

25-397-39-89 **Al** 1

C plates – for piriform rim placement



25-398-27-09 Ti 1
 25-398-27-71 Ti 1

Mini plate, 4-hole, C-shape,
 small, w/tab
 = 0.8 mm

25-398-27-89 Al 1



25-398-31-09 Ti 1
 25-398-31-71 Ti 1

Mini plate, 4-hole, C-shape,
 medium, w/tab
 = 0.8 mm

25-398-31-89 Al 1



25-398-35-09 Ti 1
 25-398-35-71 Ti 1

Mini plate, 4-hole, C-shape,
 large, w/tab
 = 0.8 mm

25-398-35-89 Al 1



25-398-39-09 Ti 1
 25-398-39-71 Ti 1

Mini plate, 4-hole, C-shape,
 extra large, w/tab
 = 1.0 mm

25-398-39-89 Al 1

T plates – for canine-bicuspid multisegment placement



25-399-26-09 Ti 1
 25-399-26-71 Ti 1

Mini plate, 4-hole, T-shape,
 small, w/tab
 = 0.8 mm

25-399-26-89 Al 1



25-399-32-09 Ti 1
 25-399-32-71 Ti 1

Mini plate, 4-hole, T-shape,
 medium, w/tab
 = 0.8 mm

25-399-32-89 Al 1



25-399-37-09 Ti 1
 25-399-37-71 Ti 1

Mini plate, 4-hole, T-shape,
 large, w/tab
 = 1.0 mm

25-399-37-89 Al 1



Plate profile



Titanium



Aluminum



Quantity / units per package



Sterile packed implants



Template

BSSO plates for advancement, setbacks, and mandibular fractures

- Plates are designed for all sizes of sagittal osteotomy advancement or setback.
- 1-mm etched lines facilitate precise fitting bends to bone.
- Tabs are designed to facilitate plate bending, try in, and screw placement.
- Tabs are designed to facilitate passive fit on the bone avoiding condylar torque.
- Tabs are removed after plate fixation to bone.



BSSO plates – for advancement, setbacks, and mandibular fractures

1/1				
25-396-29-09	25-396-34-09	25-396-39-09	25-396-44-09	25-396-56-09
25-396-29-71	25-396-34-71	25-396-39-71	25-396-44-71	25-396-56-71
Mini plate, 4-hole, straight small, w/tab	Mini plate, 4-hole, straight medium, w/tab	Mini plate, 4-hole, straight large, w/tab	Mini plate, 4-hole, straight extra large, w/tab	Mini plate, 6-hole, straight extra large, w/tab
= 1.0 mm	= 1.0 mm	= 1.0 mm	= 1.0 mm	= 1.0 mm
25-396-29-89	25-396-34-89	25-396-39-89	25-396-44-89	25-396-56-89

Chin plates for advancement or setback genioplasty

- Plates are pre-bent for advancements from 2 - 10 mm.
- Unique design facilitates level, midline, and shape control of genioplasty.
- Tabs allow precise screw placement and accuracy of chin movements.
- Small sizes (2, 3, 4 mm) are available for precise, aesthetic chin advancements.
- Plate reversal allows for genioplasty setbacks.

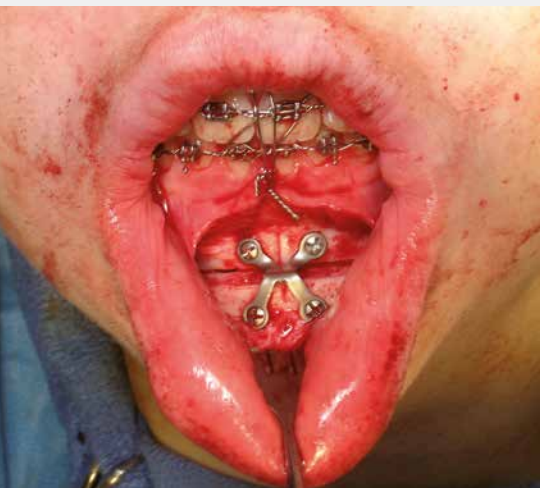

Chin plates - for advancement or setback genioplasty

$\frac{1}{4}$

50-304-02-09 **Ti** 1
50-304-02-71 **Ti** 1
Genioplasty plate, double Y-shape, 2.0 mm, w/tab,
± = 0.8 mm

50-304-03-09 **Ti** 1
50-304-03-71 **Ti** 1
Genioplasty plate, double Y-shape, 3.0 mm, w/tab,
± = 0.8 mm

50-304-04-09 **Ti** 1
50-304-04-71 **Ti** 1
Genioplasty plate, double Y-shape, 4.0 mm, w/tab,
± = 0.8 mm

$\frac{1}{4}$

50-304-06-09 **Ti** 1
50-304-06-71 **Ti** 1
Genioplasty plate, double Y-shape, 6.0 mm, w/tab,
± = 0.8 mm

50-304-08-09 **Ti** 1
50-304-08-71 **Ti** 1
Genioplasty plate, double Y-shape, 8.0 mm, w/tab,
± = 0.8 mm

50-304-10-09 **Ti** 1
50-304-10-71 **Ti** 1
Genioplasty plate, double Y-shape, 10.0 mm, w/tab,
± = 0.8 mm



Titanium



Stainless steel



Quantity / units per package



Sterile packed implants

2.0-mm maxDrive® Screws, Screwdrivers, Blades and Twist Drills

maxDrive®



Mini Screws

self-retaining

	Ø x Length	maxDrive®	STERILE R
	2.0 x 4 mm	25-872-04-09	25-872-04-75
2.0 x 5 mm	25-872-05-09	25-872-05-75	
2.0 x 6 mm	25-872-06-09	25-872-06-75	
2.0 x 7 mm	25-872-07-09	25-872-07-75	
2.0 x 9 mm	25-872-09-09	25-872-09-75	
2.0 x 11 mm	25-872-11-09	25-872-11-75	
2.0 x 13 mm	25-872-13-09	25-872-13-75	
2.0 x 15 mm	25-872-15-09	25-872-15-75	
2.0 x 17 mm	25-872-17-09	25-872-17-75	
2.0 x 19 mm	25-872-19-09		

Emergency Screws

self-retaining

	Ø x Length	maxDrive®	STERILE R
	2.3 x 4 mm	25-873-44-09	25-873-44-75
2.3 x 5 mm	25-873-45-09	25-873-45-75	
2.3 x 7 mm	25-873-47-09	25-873-47-75	
2.3 x 9 mm	25-873-49-09		

Drill-Free Screws

self-retaining

	Ø x Length	maxDrive®	STERILE R
	2.0 x 5 mm	25-879-05-09	25-879-05-75
2.0 x 6 mm	25-879-06-09		
2.0 x 7 mm	25-879-07-09	25-879-07-75	
2.0 x 9 mm	25-879-09-09	25-879-09-75	

maxDrive®



Screwdrivers and Blades

			
Blades suitable for	25-402-99-07*	25-407-04-04* flattened	50-425-05-07* rigid, flattened
25-491-97-07	2.0/2.3 mm	x	
25-486-97-07	2.0/2.3 mm		x

* For storage in Level One modules

Twist Drills

St

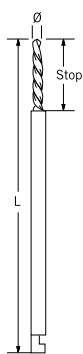

J-Notch attachment

Ø x Length (mm)	Stop (mm)	Item No.	
1.5 x 50	5	25-449-05-07	5
1.5 x 50	5	25-449-05-91	1
1.5 x 50	5	25-449-05-71	1
1.5 x 50	7	25-449-07-07	5
1.5 x 50	7	25-449-07-91	1
1.5 x 50	7	25-449-07-71	1
1.5 x 50	9	25-449-09-07	5
1.5 x 50	9	25-449-09-91	1
1.5 x 50	9	25-449-09-71	1
1.5 x 50	11	25-449-11-07	5
1.5 x 50	11	25-449-11-91	1
1.5 x 50	20	25-449-16-07	5
1.5 x 50	20	25-449-16-91	1
1.5 x 50	20	25-449-16-71	1
1.5 x 70	10	25-458-16-07	5
1.5 x 70	10	25-458-16-91	1
1.5 x 70	–	25-461-16-07	5
1.5 x 70	–	25-461-16-91	1
1.5 x 105	5	50-515-05-07	1
1.5 x 115	–	25-469-11-07	1
1.5 x 115	–	25-469-11-71	1



St



Dental attachment

Ø x Length (mm)	Stop (mm)	Item No.	
1.5 x 45	5	25-459-05-07	1
1.5 x 45	7	25-459-07-07	1
1.5 x 45	15	25-459-15-07	1
1.5 x 34	19	50-924-00-07	1
1.5 x 20	7	50-924-07-07	1
1.5 x 22	9	50-924-09-07	1

St

Stainless steel

Fz

Ferrozell

1

Quantity / units per package

Standard Instruments

Tips and profiles shown 1:1



48-701-22-07

22 cm / 8 5/8"

Ascending ramus elevator

St 1 Fz



48-703-19-07

19 cm / 7 1/2"

Molt curette

St 1

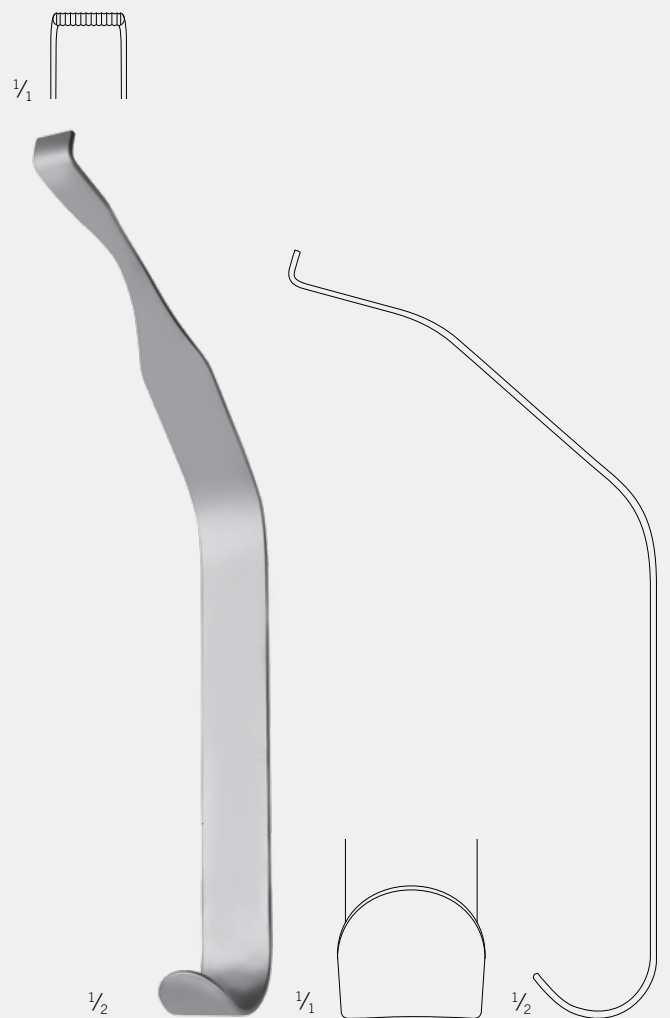

48-704-22-07

20 cm / 7 7/8"

BSSO lingual retractor

St 1



48-705-14-07
20 cm / 7 $\frac{7}{8}$ "
BSSO condylar seating fork

St 1



48-706-18-07
17 cm / 6 $\frac{3}{4}$ "
Mandibular body retractor

St 1



48-707-14-07
16.5 cm / 6 $\frac{1}{2}$ "
Maxillary sinus curette

St 1

St

Stainless steel

1

Quantity / units per package

Standard Instruments

Tips and profiles shown 1:1

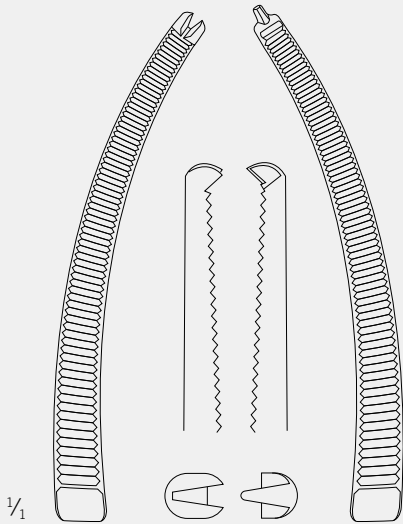

1/2

48-708-01-07

Self-retaining coronoid retractor
1 x 2 teeth

St 1

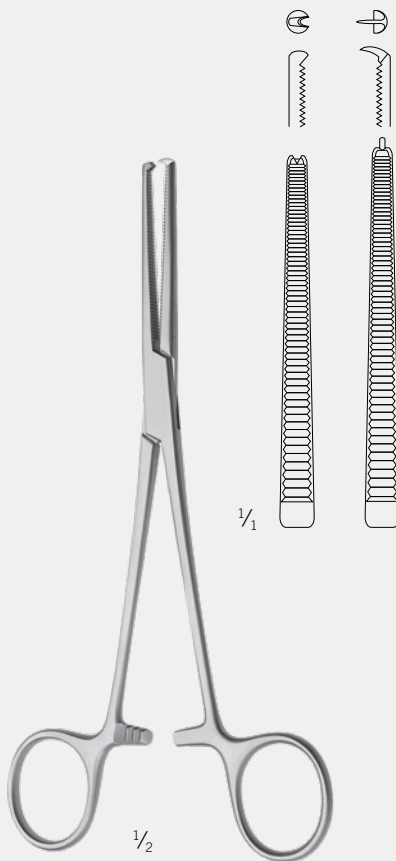

1/2

48-708-14-07

18.5 cm / 7 1/4"
Arnett bone clamp
1 x 2 teeth

St 1

- Used to hold condylar fragment while stretching tooth bearing fragment periosteotomy connective tissue.
- Used from B point wire to nasal floor compression.
- Not used for bicortical screw placement.



1/2

48-709-18-07

20 cm / 7 7/8"
Le Fort I posterior retractor

St 1



48-711-22-07
22.5 cm / 8 7/8"
Descending palatine canal dissector

St 1



48-711-23-07
23 cm / 9 1/8"
BSSO inferior alveolar nerve dissector
2 bend

St 1



48-711-24-07
23 cm / 9 1/8"
BSSO inferior alveolar nerve dissector

St 1



48-711-25-07
23 cm / 9 1/8"
Le Fort I and BSSO incision closure retractor
right angle style

St 1

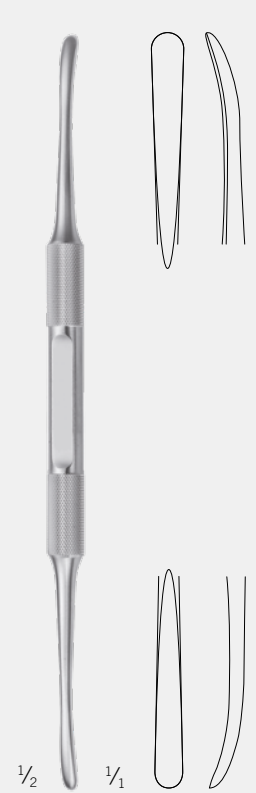

48-712-12-07
20 cm / 7 7/8"
Le Fort I nasal floor/
inferior septum elevator

St 1

St

Stainless steel

1

Quantity / units per package

Standard Instruments

Tips and profiles shown 1:1



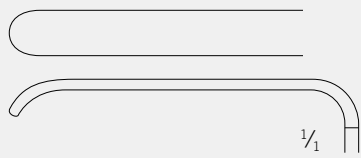

1/2

48-717-42-07

22 cm / 8 5/8"

Chin osteotomy
mental nerve retractor
6.5 x 45 mm

St 1

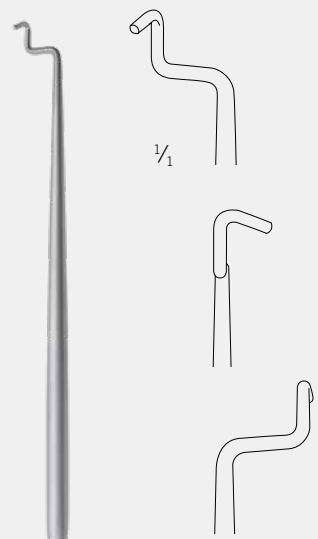

1/2

48-723-22-07

22 cm / 8 5/8"

MS Le Fort I
interdental osteotomy
tissue retractor

St 1

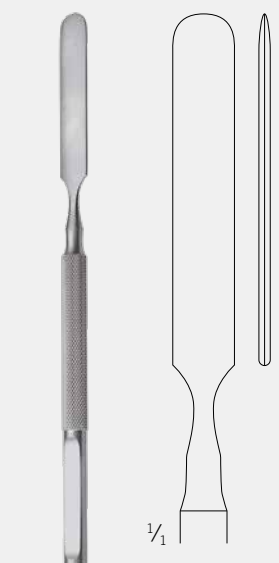

1/2

48-725-18-07

18 cm / 7 1/8"

Interdental
osteotome
8 mm

St 1

St

Stainless steel

Fz

Ferrozell

1

Quantity / units per package

Standard Instruments

Tips and profiles shown 1:1

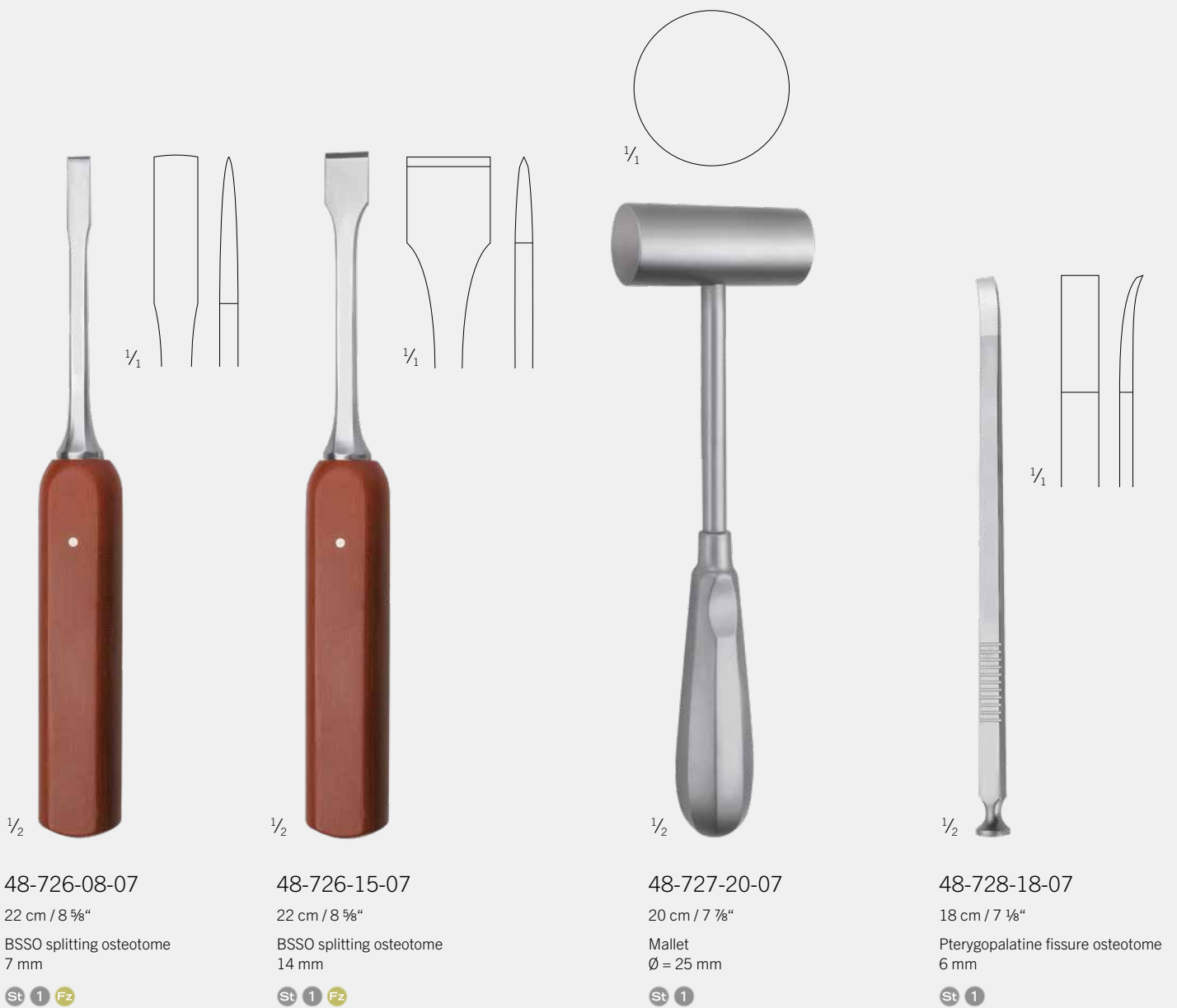

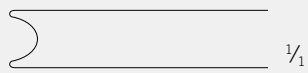

1/1

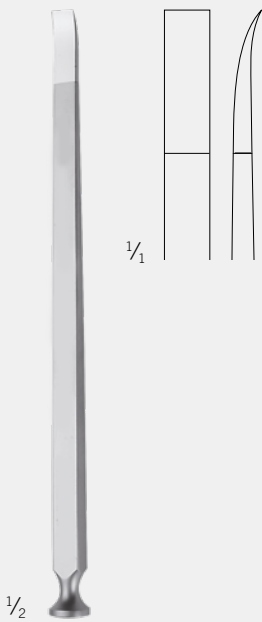

1/2

48-728-19-07
16 cm / 6 3/8"
BSSO splitting osteotome
6 mm

St 1



1/2

48-729-55-07
22 cm / 8 5/8"
BSSO transoral drill
and screw retractor
7 x 35 mm

St 1



1/2

48-731-14-07
14,5 cm / 5 3/4"
Nasal screw to incisor
measurement gauge

St 1

St

Stainless steel

1

Quantity / units per package

Standard Instruments

Tips and profiles shown 1:1



48-731-22-07

21 cm / 8 1/4"

Periosteal elevator

St 1



48-731-25-07

24 cm / 9 1/2"

Periosteal elevator
slight curve

St 1



48-735-19-07

19 cm / 7 1/2"

Chin osteotomy midline flap retractor
8.5 mm

St 1



48-738-12-07

12.5 cm / 4 7/8"

3-prong multipurpose plate bender

St 1

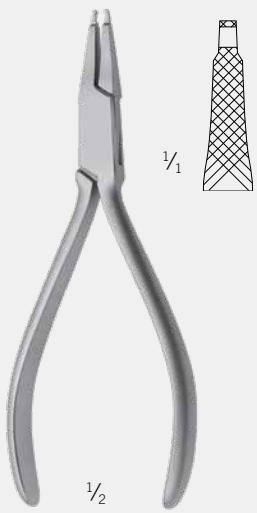

48-738-13-07
13 cm / 5 1/8"
Le Fort I multipurpose plate bender

St 1

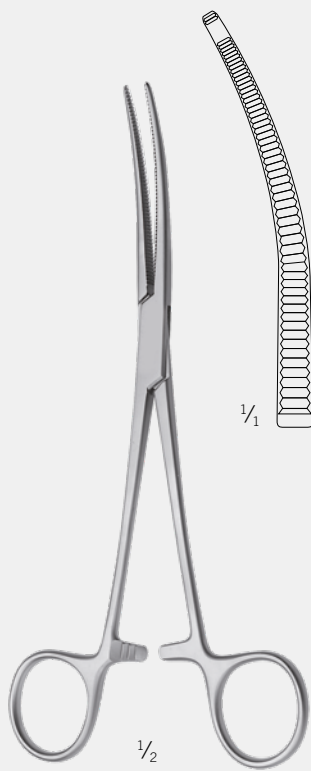

48-739-18-07
18.5 cm / 7 1/4"
Arnett-style plate holder

St 1

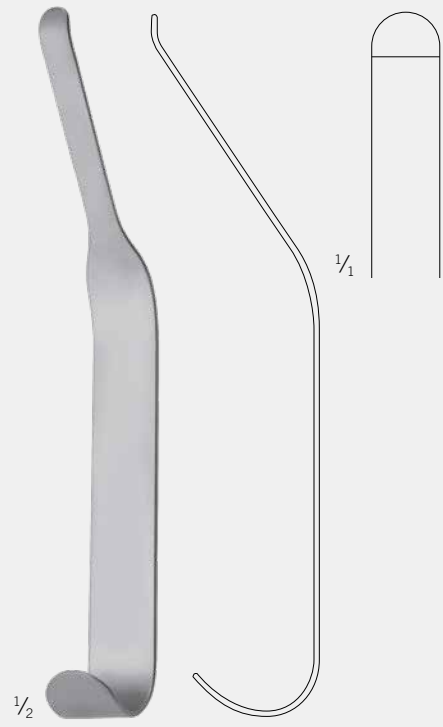

48-740-20-07
18.5 cm / 7 1/4"
Le Fort I nasal mucosa retractor

St 1



55-961-32-04

2.0-mm Arnett FAB Module complete, no implants

2.0-mm Arnett FAB Module

55-961-32-04 Arnett Module complete consisting of:	
55-962-03-04	Insert Module, with red side rails
55-963-52-04	Lid for Arnett module
55-964-69-04	Insert for Arnett module "Type 1"
55-964-80-04	Insert for Arnett module "Type 2"

The insert 55-964-69-04 is designed for the following implants:	
25-396-29-09	Arnett plate, 4-holes, straight, small
25-396-34-09	Arnett plate, 4-holes, straight, medium
25-396-39-09	Arnett plate, 4-holes, straight, large
25-396-44-09	Arnett plate, 4-holes, straight, XL
25-396-56-09	Arnett plate, 6-holes, straight, large
25-399-26-09	Arnett plate, T-shaped, 0.8 mm, small
25-399-32-09	Arnett plate, T-shaped, 0.8 mm, medium
25-399-37-09	Arnett plate, T-shaped, 1.0 mm, large
50-304-02-09	Arnett genioplasty plate, 2 mm
50-304-03-09	Arnett genioplasty plate, 3 mm
50-304-04-09	Arnett genioplasty plate, 4 mm
50-304-06-09	Arnett genioplasty plate, 6 mm
50-304-08-09	Arnett genioplasty plate, 8 mm
50-304-10-09	Arnett genioplasty plate, 10 mm

The insert 55-964-80-04 is designed for the following implants:	
25-397-27-09	Arnett plate, L-shaped, 0.8 mm, small
25-397-31-09	Arnett plate, L-shaped, 0.8 mm, medium
25-397-35-09	Arnett plate, L-shaped, 0.8 mm, large
25-397-39-09	Arnett plate, L-shaped, 1.0 mm, XL
25-398-27-09	Arnett plate, C-shaped, 0.8 mm, small
25-398-31-09	Arnett plate, C-shaped, 0.8 mm, medium
25-398-35-09	Arnett plate, C-shaped, 0.8 mm, large
25-398-39-09	Arnett plate, C-shaped, 1.0 mm, XL

25

25-396-29-098, 22
 25-396-29-718
 25-396-29-898
 25-396-34-098, 22
 25-396-34-718
 25-396-34-898
 25-396-39-098, 22
 25-396-39-718
 25-396-39-898
 25-396-44-098, 22
 25-396-44-718
 25-396-44-898
 25-396-56-098, 22
 25-396-56-718
 25-396-56-898
 25-397-27-096, 22
 25-397-27-716
 25-397-27-896
 25-397-31-096, 22
 25-397-31-716
 25-397-31-896
 25-397-35-096, 22
 25-397-35-716
 25-397-35-896
 25-397-39-096, 22
 25-397-39-716
 25-397-39-896
 25-398-27-097, 22
 25-398-27-717
 25-398-27-897
 25-398-31-097, 22
 25-398-31-717
 25-398-31-897
 25-398-35-097, 22
 25-398-35-717
 25-398-35-897
 25-398-39-097, 22
 25-398-39-717
 25-398-39-897
 25-399-26-097, 22
 25-399-26-717
 25-399-26-897
 25-399-32-097, 22
 25-399-32-717
 25-399-32-897
 25-399-37-097, 22
 25-399-37-717
 25-399-37-897
 25-402-99-0710
 25-407-04-0410
 25-439-19-075
 25-449-05-0711
 25-449-05-7111
 25-449-05-9111
 25-449-07-0711
 25-449-07-9111
 25-449-09-0711
 25-449-09-7111
 25-449-09-9111
 25-449-11-0711
 25-449-11-9111
 25-449-16-0711
 25-449-16-7111

25-449-16-9111
 25-458-16-0711
 25-458-16-9111
 25-459-05-0711
 25-459-07-0711
 25-459-15-0711
 25-461-16-0711
 25-461-16-9111
 25-469-11-0711
 25-469-11-7111
 25-486-97-0710
 -25-491-97-0710
 25-872-04-0910
 25-872-04-7510
 25-872-05-0910
 25-872-05-7510
 25-872-06-0910
 25-872-06-7510
 25-872-07-0910
 25-872-07-7510
 25-872-09-0910
 25-872-09-7510
 25-872-11-0910
 25-872-11-7510
 25-872-13-0910
 25-872-13-7510
 25-872-15-0910
 25-872-15-7510
 25-872-17-0910
 25-872-17-7510
 25-872-19-0910
 25-873-44-0910
 25-873-44-7510
 25-873-45-0910
 25-873-45-7510
 25-873-47-0910
 25-873-47-7510
 25-873-49-0910
 25-879-05-0910
 25-879-05-7510
 25-879-06-0910
 25-879-07-0910
 25-879-07-7510
 25-879-09-0910
 25-879-09-7510

48

48-701-22-0712
 48-703-19-0712
 48-704-22-0712
 48-705-14-0713
 48-706-18-0713
 48-707-14-0713
 48-708-01-0714
 48-708-14-0714
 48-709-18-0714
 48-711-22-0715
 48-711-23-0715
 48-711-24-0715
 48-711-25-0715
 48-712-12-0715
 48-716-22-0716
 48-716-42-0716
 48-716-55-0716

48-717-42-0717
 48-723-22-0717
 48-725-18-0717
 48-726-08-0718
 48-726-15-0718
 48-727-20-0718
 48-728-18-0718
 48-728-19-0719
 48-729-55-0719
 48-731-14-0719
 48-731-22-0720
 48-731-25-0720
 48-735-19-0720
 48-738-12-0720
 48-738-13-0721
 48-739-18-0721
 48-740-20-0721

50

50-304-02-099, 22
 50-304-02-719
 50-304-03-099, 22
 50-304-03-719
 50-304-04-099, 22
 50-304-04-719
 50-304-06-099, 22
 50-304-06-719
 50-304-08-099, 22
 50-304-08-719
 50-304-10-099, 22
 50-304-10-719
 50-425-05-0710
 50-515-05-0711
 50-924-00-0711
 50-924-07-0711
 50-924-09-0711

55

55-961-32-045, 22
 55-962-03-0422
 55-963-52-0422
 55-964-69-0422
 55-964-80-0422

KLS Martin Group

KLS Martin Australia Pty Ltd.

Sydney · Australia
Tel. +61 2 9439 5316
australia@klsmartin.com

Martin Italia S.r.l.

Milan · Italy
Tel. +39 039 605 67 31
italia@klsmartin.com

Martin Nederland/Marned B.V.

Huizen · Netherlands
Tel. +31 35 523 45 38
infonl@klsmartin.com

KLS Martin UK Ltd.

Reading · United Kingdom
Tel. +44 118 467 1500
uk@klsmartin.com

KLS Martin do Brasil Ltda.

São Paulo · Brazil
Tel. +55 11 3554 2299
brazil@klsmartin.com

Nippon Martin K.K.

Tokyo · Japan
Tel. +81 3 3814 1431
nippon@klsmartin.com

Gebrüder Martin GmbH & Co. KG

Moscow · Russia
Tel. +7 499 792 76 19
russia@klsmartin.com

KLS Martin LP

Jacksonville · Florida, USA
Tel. +1 904 641 77 46
usa@klsmartin.com

KLS Martin Medical (Shanghai) International Trading Co., Ltd

Shanghai · China
Tel. +86 21 5820 6251
china@klsmartin.com

KLS Martin SE Asia Sdn. Bhd.

Penang · Malaysia
Tel. +604 506 2380
malaysia@klsmartin.com

KLS Martin Taiwan Ltd.

Taipei 106 · Taiwan
Tel. +886 2 2325 3169
taiwan@klsmartin.com

KLS Martin India Pvt Ltd.

Chennai · India
Tel. +91 44 66 442 300
india@klsmartin.com

KLS Martin de México S.A. de C.V.

Mexico City · Mexico
Tel. +52 55 7572 0944
mexico@klsmartin.com

Gebrüder Martin GmbH & Co. KG

Dubai · United Arab Emirates
Tel. +971 4 454 16 55
middleeast@klsmartin.com

Gebrüder Martin GmbH & Co. KG

A company of the KLS Martin Group

KLS Martin Platz 1 · 78532 Tuttlingen · Germany
P.O. Box 60 · 78501 Tuttlingen · Germany
Tel. +49 7461 706-0 · Fax +49 7461 706-193
info@klsmartin.com · www.klsmartin.com