

Kraniomaxillofaziale Chirurgie – Spezialinstrumente
Craniomaxillofacial Surgery – Special Instruments
Cirugía cráneo-maxilofacial – instrumentos especiales
Chirurgie crânio-maxillofaciale – instruments spécifiques
Chirurgia cranio-maxillofaciale – strumenti speciali





Surgical Innovation is our Passion



Spezialinstrumente für die Kraniomaxillofaziale Chirurgie

Besondere Disziplinen benötigen spezielle Werkzeuge. Dieser Katalog enthält eine Zusammenstellung von etablierten Instrumenten die von namhaften Mund-, Kiefer- und Gesichtschirurgen entwickelt wurden. Der ständige Dialog mit weltweit führenden Spezialisten zeichnet den kontinuierlichen Fortschritt in unserem Produktportfolio aus. Gleichwohl sind alle unsere Instrumente qualitativ erstklassig und werden höchsten Ansprüchen gerecht.

GB

Special instruments for craniomaxillofacial surgery

Specialist disciplines require special tools. This catalog contains a listing of established instruments that have been developed by renowned maxillofacial surgeons. A constant dialog with leading specialists helps us to maintain continuous progress in our product portfolio. In addition, all of our instruments are manufactured to the highest quality standards and are designed to meet the most exacting demands.

ES

Instrumentos especiales para la cirugía craneomaxilofacial

Las especialidades singulares requieren herramientas específicas. Este catálogo contiene una compilación de instrumentos acreditados que han sido desarrollados por renombrados cirujanos orales y maxilofaciales. El diálogo continuo con especialistas destacados a nivel mundial distingue el progreso continuo en nuestro catálogo de productos. Así, nuestros instrumentos son de primera calidad y satisfacen los requisitos más exigentes.

F

Instruments spécifiques à la chirurgie crâniomaxillofaciale

Des disciplines particulières nécessitent des outils spécifiques. Le présent catalogue contient une compilation d'instruments éprouvés qui ont été développés par de célèbres spécialistes en chirurgie buccale et chirurgiens maxillofaciaux. L'évolution continue de notre gamme de produits est le fruit du dialogue permanent que nous entretenons avec les principaux spécialistes mondiaux. Tous nos instruments sont néanmoins de très haute qualité et conviennent aux exigences les plus élevées.

I

Strumenti speciali per la chirurgia craniomaxillofaciale

Discipline speciali richiedono strumenti speciali. Questo catalogo contiene una panoramica di strumenti consolidati messi a punto da rinomati chirurghi oro-maxillofacciali. Il dialogo costante con specialisti di fama mondiale contraddistingue la continua evoluzione della nostra gamma di prodotti. Tutti i nostri strumenti sono di qualità eccellente e soddisfano i requisiti più rigorosi.



Qualitätssicherung ohne Kompromisse

Unsere Produkte erfüllen den Anspruch anwendungsbezogener Funktionalität, intelligenter Handhabung und hoher Qualität. Und wenn es um die Erfüllung dieses Anspruchs geht, machen wir keine Kompromisse. Um dies zu gewährleisten, unterhält KLS Martin ein eigenes hochmodernes Labor sowie ein Technikum, in denen die Qualität unserer Erzeugnisse – auch unter extremen Bedingungen – auf „Herz und Nieren“ getestet und dokumentiert werden.

GB

Quality assurance uncompromising

Our products are designed to consistently meet high demands for application-oriented functionality, intelligent operation and top quality. And we are not prepared to compromise when it comes to meeting the justified expectations of our customers, present and future – your standards become ours. KLS Martin runs their own ultramodern laboratories and a pilot plant, where our products are stress-tested under extreme conditions – every step

ES

Un seguro de calidad sin compromisos

Nuestros productos cumplen el requisito de estar dotados de la funcionalidad conforme a su aplicación, su manipulación es inteligente y son de alta calidad. No transigimos a la hora de cumplir con estas condiciones esenciales. Por este motivo, KLS Martin mantiene un laboratorio propio, altamente moderno, así como una escuela técnica, donde se ensaya y documenta la calidad de nuestros productos – inclusive bajo condiciones extremas –, examinándolos “hasta la médula”.

F

Une assurance qualité sans compromis

Nos produits répondent aux exigences requises par une fonctionnalité relative à l'application, un maniement intelligent et une qualité élevée. Et nous n'acceptons aucun compromis lorsqu'il s'agit de répondre à ces exigences. KLS Martin possède à ce but son propre laboratoire ultramoderne et son centre technique dans lesquels la qualité de nos produits fabriqués est testée minutieusement – même sous des extrêmes conditions – et les résultats des tests sont documentés.

I

Assicurazione della qualità senza compromessi

I nostri prodotti sono stati progettati guardando alle esigenze della prassi applicativa, offrono una manipolazione intelligente e sono di qualità elevata. A tale riguardo non facciamo compromessi. Per garantire questo standard, KLS Martin ha un laboratorio altamente moderno e un centro tecnologico in cui controlla e documenta la qualità di tutti i prodotti, anche in condizioni estreme.

Wir setzen Standards für die Instrumentenaufbereitung

Wie lassen sich Medizinprodukte vor mechanischer, thermischer oder chemischer Belastung schützen? Was muss man bei der Aufbereitung und Pflege besonders feingliedriger Mikrochirurgieinstrumente berücksichtigen? Als Mitglied wichtiger Gremien und Arbeitskreise – wie z. B. dem Arbeitskreis Instrumenten-Aufbereitung AKI – gibt KLS Martin Antworten und erarbeitet Lösungen für die optimale Aufbereitung und Pflege von Instrumenten. Von der Auswahl angemessener Reinigungsverfahren bis hin zu Sterilisationsverfahren.

GB

Standards and best practice: instrument preparation

How best to protect surgical instruments from mechanical, thermal and chemical stresses? What steps are performed to ensure optimal preparation and care of highly delicate microsurgical instruments? KLS Martin, in their capacity as member of important advisory boards and working groups – for example, Working Group Instrument Preparation AKI – is in a position to provide answers and solutions to all inquiries with regard to the optimal preparation and care of instruments, ranging from knowledgeable advice on appropriate cleaning methods through sterilization processes.

ES

Los estándares y la mejor práctica para la preparación de instrumentos

¿Cómo se pueden proteger los productos médicos contra la actuación de factores mecánicos, térmicos y químicos? ¿Qué es lo que hay que considerar en el momento de preparación y cuidado del instrumental microquirúrgico, constituido fundamentalmente por componentes finos? En función de miembro de asociaciones y comités laborales importantes – como por ejemplo, el Comité Alemán de Trabajo de Preparación de Instrumental AKI – KLS Martin ofrece respuestas y elabora soluciones para el tratamiento y cuidado óptimos del instrumental. Éstas abarcan desde la selección de métodos de limpieza adecuados hasta el procedimiento de esterilización.

F

Normes et pratiques idéales pour la préparation des instruments

Comment protéger les produits médicaux contre d'éventuelles contraintes mécaniques, thermiques ou chimiques? Quels points doivent être pris en considération pour le traitement et l'entretien d'instruments micro-chirurgicaux à fine ossature? A titre de membre d'importants organismes et cercles de travail, tels que par exemple l'AKI (Arbeitskreis Instrumenten-Aufbereitung = cercle de travail pour le traitement des instruments), KLS Martin donne des réponses et élabore des solutions pour assurer un traitement et un entretien optimaux des instruments. Depuis la sélection de procédés de nettoyage adéquats jusqu'au procédé de stérilisation.

I

Standard e “best practice” per la preparazione degli strumenti

Come si possono proteggere gli strumenti medici da agenti aggressivi di tipo meccanico, termico o chimico? Cosa occorre tenere presente nella preparazione e nella manutenzione di strumenti microchirurgici particolarmente delicati? Quale membro di importanti organi e gruppi di lavoro, come ad esempio AKI, il gruppo tedesco di lavoro per la corretta preparazione degli strumenti, KLS Martin dà risposta e sviluppa soluzioni per la preparazione e la manutenzione ottimali degli strumenti, dalla scelta dei sistemi di pulizia più idonei alle procedure di sterilizzazione.





Wir bieten Ihnen die Möglichkeit, zu Ihrem KLS-Martin-Produkt die passende Gebrauchsanweisung digital anzufordern.

Gebrauchsanweisung anfordern

Anrede

Titel



Erläuterungen zum Katalog

Catalog explanations

Explicaciones complementarias al catálogo

Explications sur le catalogue

Spiegazioni relative al catalogo



Edelstahl · stainless steel
acero inoxidable · acier inoxydable
acciaio inossidabile



Titan · titanium · titanio
titane · titanio



Verchromt · chrome-plated
cromado · chromé · cromato



Ferrozell



Silikon · Silicone
Silicona · Silicone · Silicone



Solid Black
Hartstoffbeschichtung (für eine längere Standzeit)
Hard-coated surface (for extended life)
Recubrimiento con material duro (para una vida útil más larga)
Revêtement à surface dure (pour une durée de vie prolongée)
Rivestimento in materiale rigido (per una più lunga durata)



Verweis · Reference · Referencia
Référence · Rimando



Anzahl Zähne · number of teeth
cantidad de dientes · quantité de
dents · quantità di denti



Kaltlicht · cold light · luz fría
lumière froide · luce fredda

TC GOLD

TC-Hartmetall im Arbeitsende
Tungsten carbide in working end
Carburo de tungsteno en el extremo de trabajo
Carbure de tungstène sur extrémité de travail
Carburo di tungsteno nell'estremità operativa



Atrauma

Atrauma-Zahnung
Atraumatic serration
Dentado atraumático
Dentelure Atrauma
Dentatura atraumatica

Übersichtstafel
Table of Contents
Tabla de catálogo
Contenu
Indice di catalogo





Übersichtstafel

Table of Contents

Tabla de catálogo

Contenu

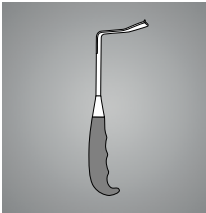
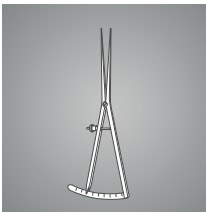
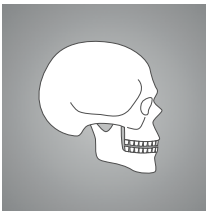
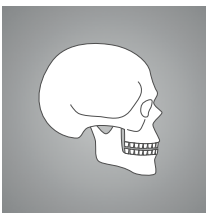
Indice di catalogo

1-4		Jaboma Spalt-Instrumentarium für Lippen-, Kiefer-, Gaumenspalte Jaboma Cleft Palate Set for Cleft Palate Jaboma Instrumental para operaciones del paladar para fisura paladar Set d'instruments Jaboma pour fente du palais pour fente labio-maxillo-palatine Set di strumenti Jaboma per cheilo-labbro-palato schisi
5-11		Instrumente der Endo-Condyle Unit Endo-Condyle Unit instruments Instrumentos Endo-Condyle Unit Instruments unité endo-condylienne Strumenti per Endo-Condyle Unit
13-14		Messzirkel Calipers Compases Compas Compassi
15-115		Spezialinstrumente für die Kraniomaxillofaziale Chirurgie Special instruments for craniomaxillofacial surgery Instrumentos especiales para la cirugía cráneo-maxilofacial Instruments spécifiques à la chirurgie crânio-maxillofaciale Strumenti speciali per la Chirurgia cranio-maxillofaciale
116-125		Instrumentarium Arnett FAB Orthognathie-System Instrumentation Arnett FAB Orthognathic System Instrumental sistema ortognático FAB Arnett Instruments Arnett pour système d'orthognathie FAB Strumenti per sistema di ortognazia Arnett FAB
129-143		Index Index Indice Index Indice

**Weitere Kataloge von KLS Martin**

Zu den folgenden Produktgruppen sind jeweils eigene Kataloge verfügbar, die Sie gerne bei uns anfordern können:

Further catalogs of KLS Martin

For the following product groups additional catalogs are available. Please ask for your personal copy:

Más catálogos de KLS Martin

Para los grupos siguientes tenemos catálogos individuales disponibles. No duden pedirnos más ejemplares:

Autres catalogues de KLS Martin

Pour les groupes de produits suivants sont disponibles des catalogues additionnels dont vous pouvez demander le nombre désiré:

Altri cataloghi di KLS Martin

Per i gruppi di prodotti seguenti sono disponibili cataloghi addizionali. La preghiamo di informarci se desidera altre copie:

Deckenversorgungseinheiten
Ceiling-mounting systems
Unidades de alimentación de techo
Unités d'alimentation montées au plafond
Sistemi pensili

OP-Leuchten
Operating Theatre Lights
Lámparas de quirófano
Lampes opératoires
Lampade scialitiche

HF-Chirurgie
HF Surgery
Cirugía AF
Chirurgie HF
Chirurgia AF

Mund-, Kiefer- und Gesichtschirurgie
Oral and Craniomaxillofacial surgery
Cirugía oral y maxilofacial
Chirurgie orale et maxillofaciale
Chirurgia orale e maxillofacciale

microStop®-Sterilcontainer
microStop® Sterile Containers
Contenedores estériles microStop®
Conteneurs stériles microStop®
Contentitori per la sterilizzazione microStop®

Jaboma Spalt-Instrumentarium für Lippen-, Kiefer-, Gaumenspalte
Jaboma Cleft Palate Set for Cleft Palate
Jaboma Instrumental para operaciones del paladar para fisura paladar
Set d'instruments Jaboma pour fente du palais pour fente labio-maxillo-palatine
Set di strumenti Jaboma per cheilo-labbro-palato schisi

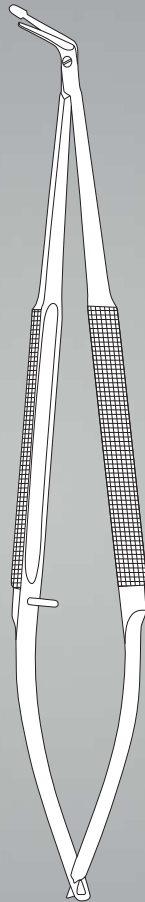

Jaboma Spalt-Instrumentarium für Lippen-, Kiefer-, Gaumenspalte

Jaboma Cleft Palate Set for Cleft Palate

Jaboma Instrumental para operaciones del paladar para fisura paladar

Set d'instruments Jaboma pour fente du palais pour fente labio-maxillo-palatine

Set di strumenti Jaboma per cheilo-labbro-palato schisi



Jaboma
11-765-18-07

18 cm / 7 1/8"

Schere, links gebogen
Scissors, left curved
Tijeras, curvo a la izquierda
Ciseaux, courbé à gauche
Forbici, curvo sinistro



Jaboma
11-767-18-07

18 cm / 7 1/8"

Schere, rechts gebogen
Scissors, right curved
Tijeras, curvo por derecho
Ciseaux, courbé à droite
Forbici, curvo a destra



Jaboma
11-769-18-07

18 cm / 7 1/8"

Mikro-Präparierschere
Micro dissecting scissors
Micro-tijeras de disección
Micro-ciseaux à dissection
Micro-forbici per dissezione



TC GOLD



Jaboma
12-276-18-07

18 cm / 7 1/8"

TC-Pinzette
TC forceps
Pinza TC
Pince TC
Pinza TC



Jaboma
12-278-18-07

18 cm / 7 1/8"

TC-Pinzette
TC forceps
Pinza TC
Pince TC
Pinza TC

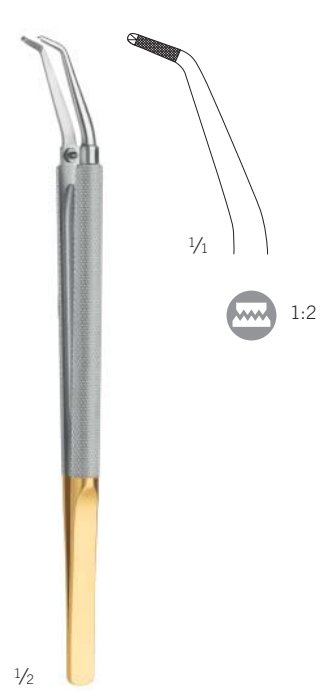

Jaboma
12-279-18-07

18 cm / 7 1/8"

TC-Pinzette
TC forceps
Pinza TC
Pince TC
Pinza TC

Jaboma Spalt-Instrumentarium für Lippen-, Kiefer-, Gaumenspalte

Jaboma Cleft Palate Set for Cleft Palate

Jaboma Instrumental para operaciones del paladar para fisura paladar

Set d'instruments Jaboma pour fente du palais pour fente labio-maxillo-palatine

Set di strumenti Jaboma per cheilo-labbro-palato schisi

TC GOLD



Jaboma
20-610-18-07

18 cm / 7 1/8"

TC-Nadelhalter
TC needle holder
Porta-aguja TC
Porte-aiguille TC
Portaghi TC

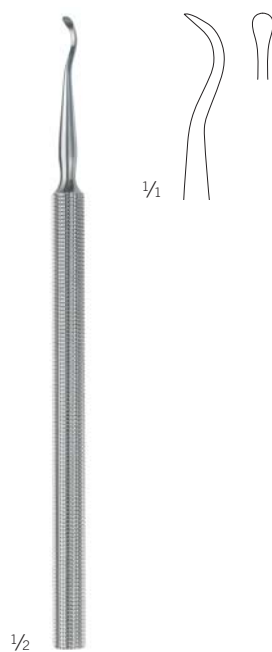

Jaboma
39-100-17-07

17 cm / 6 5/8"

Gaumenspalt-Raspatorium
Cleft palate raspatory
Periostótomo para fisura palatina
Rugine-raspatoire pour fente palatine
Periostotomo per palato schisi

Instrumente der Endo-Condyle Unit
Endo-Condyle Unit instruments, repositioning instruments
Instrumentos Endo-Condyle Unit, instrumentos de reposición
Instruments unité endo-condylienne, instruments de repositionnement
Strumenti per Endo-Condyle Unit, strumenti di riposizionamento

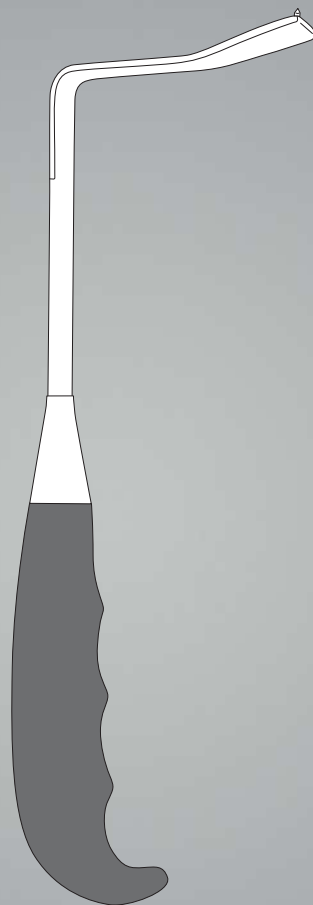

Instrumente der Endo-Condyle Unit, Repositionsinstrumente

Endo-Condyle Unit instruments, repositioning instruments

Instrumentos Endo-Condyle Unit, instrumentos de reposición

Instruments unité endo-condylienne, instruments de repositionnement

Strumenti per Endo-Condyle Unit, strumenti di riposizionamento

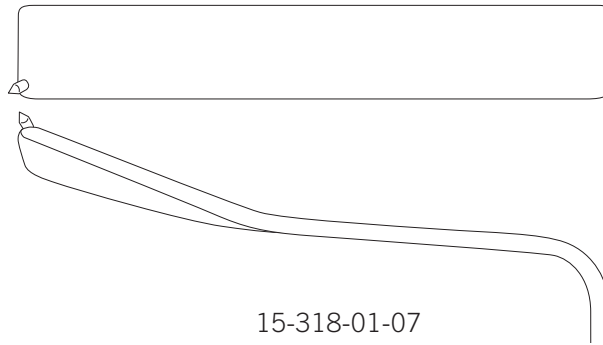

15-318-01-07

rechts
right
derecho
droit
destra

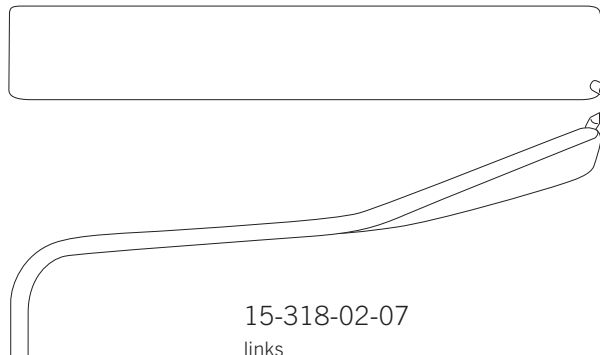

15-318-02-07

links
left
izquierdo
gauche
sinistra

15-318-01-07 -
15-318-02-07

24,5 cm/9 7/8"

Ramus-Retractor, mit Dorn
Ramus retractor, with mandrel
Retractor de rama, con espiga
Rétracteur de ramus, avec pointe
Separatore per ramo, con mandrino

Sic

Instrumente der Endo-Condyle Unit, Repositionsinstrumente

Endo-Condyle Unit instruments, repositioning instruments
Instrumentos Endo-Condyle Unit, instrumentos de reposición
Instruments unité endo-condylienne, instruments de repositionnement
Strumenti per Endo-Condyle Unit, strumenti di riposizionamento

Kraniomaxillofaziale Chirurgie

Craniomaxillofacial surgery
Cirugía cráneo-maxilofacial
Chirurgie crânio-maxillofaciale
Chirurgia cranio-maxillofaciale

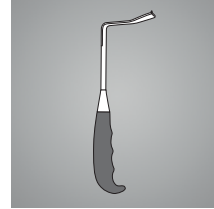

1/2

38-684-01-07

24 cm/9 1/8"

Ramus-Reetraktor, scharf
Ramus retractor, sharp
Retractor de rama, afilado
Rétracteur de ramus, aiguisé
Separatore per ramo, acuto

Sic



1/2

38-715-22 07

21,5 cm/8 1/2"

Ramus-Reetraktor mit Dorn, gewinkelt
Ramus retractor with mandrel, angled
Retractor de rama con espiga, acodado
Rétracteur de ramus avec pointe, angle
Separatore per ramo, con mandrino, angolato

Sic



1/2

38-684-02-07

25,5 cm/10"

Ramus-Reetraktor, gerade
Ramus retractor, straight
Retractor de rama, recto
Rétracteur de ramus, droit
Separatore per ramo, diritto

Sic

Instrumente der Endo-Condyle Unit, Repositionsinstrumente

Endo-Condyle Unit instruments, repositioning instruments

Instrumentos Endo-Condyle Unit, instrumentos de reposición

Instruments unité endo-condylienne, instruments de repositionnement

Strumenti per Endo-Condyle Unit, strumenti di riposizionamento

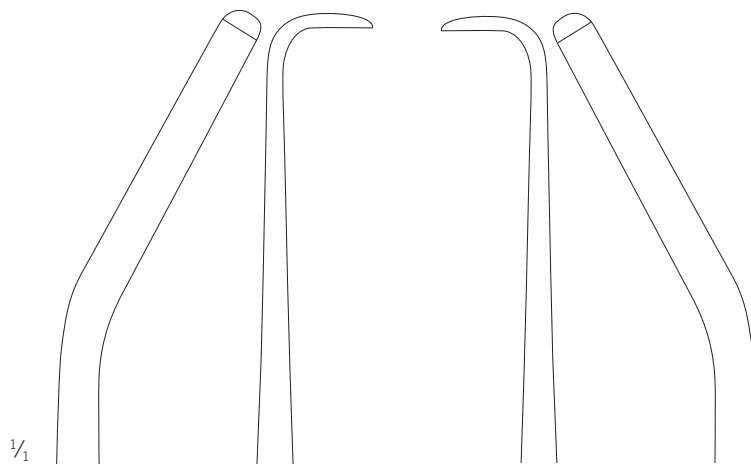

37-544-03-07

links
left
izquierdo
gauche
sinistra

37-544-04-07

rechts
right
derecho
droit
destra

37-544-03-07 -
37-544-04-07

25,5 cm/10"

Elevatorium, breit
Elevator, wide
Elevador, ancho
Élévateur, large
Elevatore, largo

Sic

Instrumente der Endo-Condyle Unit, Repositionsinstrumente

Endo-Condyle Unit instruments, repositioning instruments
Instrumentos Endo-Condyle Unit, instrumentos de reposición
Instruments unité endo-condylienne, instruments de repositionnement
Strumenti per Endo-Condyle Unit, strumenti di riposizionamento

Kraniomaxillofaziale Chirurgie

Craniomaxillofacial surgery
Cirugía cráneo-maxilofacial
Chirurgie crânio-maxillofaciale
Chirurgia cranio-maxillofaciale

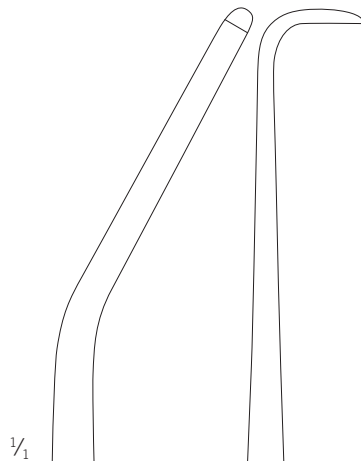
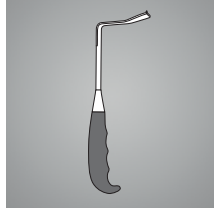

37-544-05-07

links
left
izquierdo
gauche
sinistra

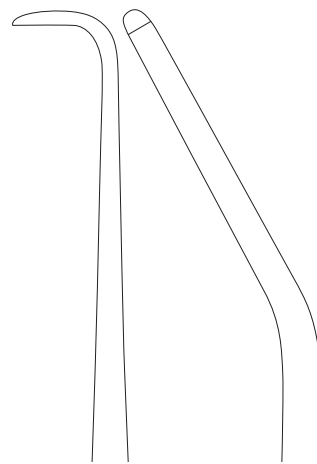

37-544-06-07

rechts
right
derecho
droit
destra

37-544-05-07 -
37-544-06-07

25,5 cm/10"

Elevatorium, schmal
Elevator, narrow
Elevador, estrecho
Élévateur, fin
Elevatore, stretto

Sic

Instrumente der Endo-Condyle Unit, Repositions- und Zugangsinstrumente

Endo-Condyle Unit instruments, repositioning and access instruments

Instrumentos Endo-Condyle Unit, instrumentos de reposición y acceso

Instruments unité endo-condylienne, instruments de repositionnement et d'accès

Strumenti per Endo-Condyle Unit, strumenti di riposizionamento e accesso

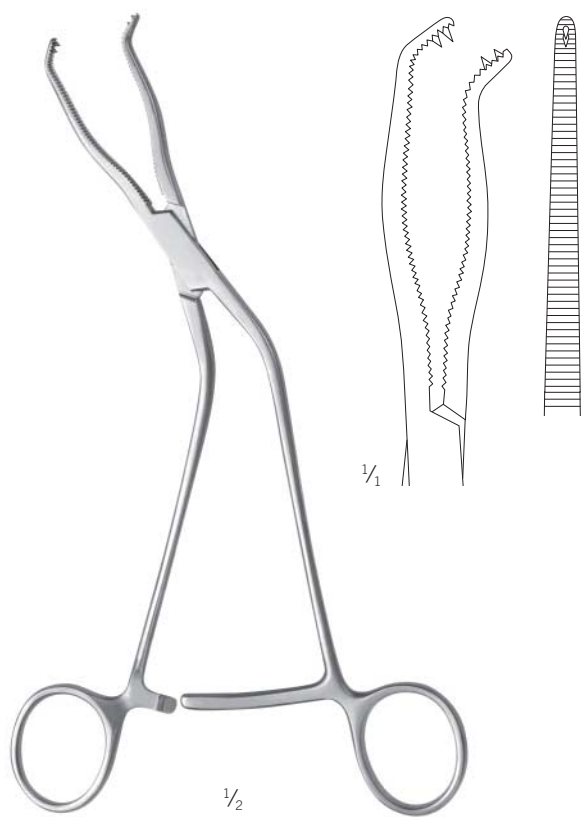

50-242-12-07

21,5 cm/8 5/8"

Repositionsklemme universell nutzbar (links+ rechts)

Endo-Condyle Unit instruments, repositioning and access instruments

Instrumentos Endo-Condyle Unit, instrumentos de reposición y acceso

Instruments unité endo-condylienne, instruments de repositionnement et d'accès

Strumenti per Endo-Condyle Unit, strumenti di riposizionamento e accesso

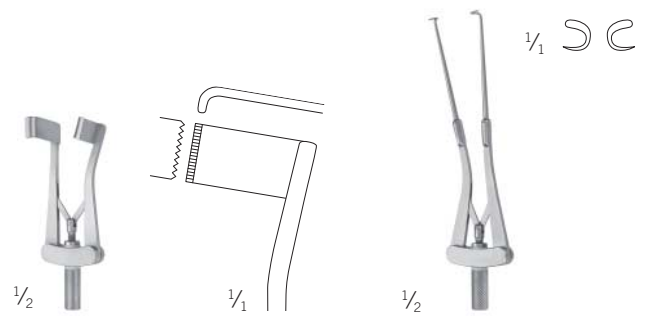

15-716-01-07

7 cm/2 3/4"

Wundspreizer, gezahnt

Surgical spreader, serrated

Separado, dentado

Écarteur autostatique, denté

Divaricatore autostatico, dentato

15-716-03-07

10 cm/3 7/8"

Wundspreizer, fein

Surgical spreader, fine

Separador, fino

Écarteur autostatique, fin

Divaricatore autostatico, fine

Instrumente der Endo-Condyle Unit, Stabilisierungsinstrumente

Endo-Condyle Unit instruments, stabilizing instruments

Instrumentos Endo-Condyle Unit, instrumentos estabilizadores

Instruments unité endo-condylienne, instruments de stabilisation

Strumenti per Endo-Condyle Unit, strumenti di stabilizzazione

Kraniomaxillofaziale Chirurgie

Craniomaxillofacial surgery

Cirugía cráneo-maxilofacial

Chirurgia crânio-maxilofaciale

Chirurgia cranio-maxillofaciale

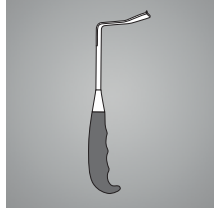

38-684-03-07

26 cm/10 5/8"

Metz-Haken, modifiziert, rechts

Metz hook, modified, right

Gancho Metz, modificado, derecha

Crochet de Metz, modifié, droit

Divaricatore di Metz, modificato, destra



38-684-04-07

26 cm/10 5/8"

Metz-Haken, modifiziert, links

Metz hook, modified, left

Gancho Metz, modificado, izquierda

Crochet de Metz, modifié, gauche

Divaricatore di Metz, modificato, sinistra



Messzirkel
Calipers
Compasses
Compas
Compassi

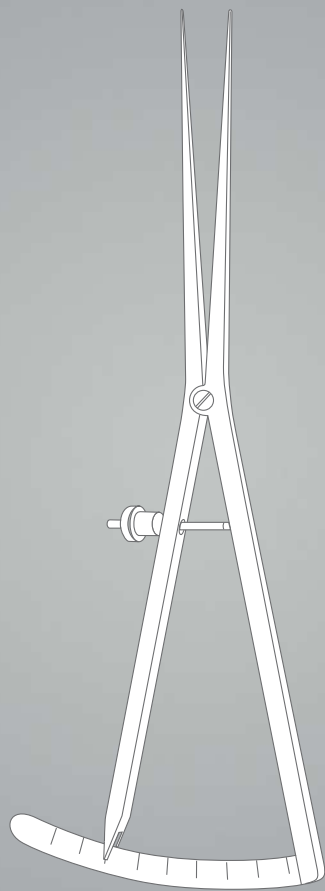

Messzirkel

Calipers

Compasses

Compas

Compassi



Castroviejo
35-133-06-07

8 cm / 3 1/8"

Messbereich
effective range
alcance eficaz
série effectif
rango effective
0-15 mm



Castroviejo
35-133-07-07

8 cm / 3 1/8"

Messbereich
effective range
alcance eficaz
série effectif
rango effective
0-20 mm



Castroviejo
35-133-09-07

8 cm / 3 1/8"

Messbereich
effective range
alcance eficaz
série effectif
rango effective
0-20 mm



Castroviejo-Epker
35-134-09-07

9 cm / 3 4/8"

Messbereich
effective range
alcance eficaz
série effectif
rango effective
0-40 mm



Castroviejo-Epker
35-134-18-07

18 cm / 7 1/8"

Messbereich
effective range
alcance eficaz
série effectif
rango effective
0-40 mm



Castroviejo-Epker
35-135-18-07

18 cm / 7 1/8"

Messbereich
effective range
alcance eficaz
série effectif
rango effective
0-40 mm

Spezialinstrumente für die Kriomaxillofaziale Chirurgie
Special instruments for craniomaxillofacial surgery
Instrumentos especiales para la cirugía cráneo-maxilofacial
Instruments spécifiques à la chirurgie crânio-maxillofaciale
Strumenti speciali per la Chirurgia cranio-maxillofaciale

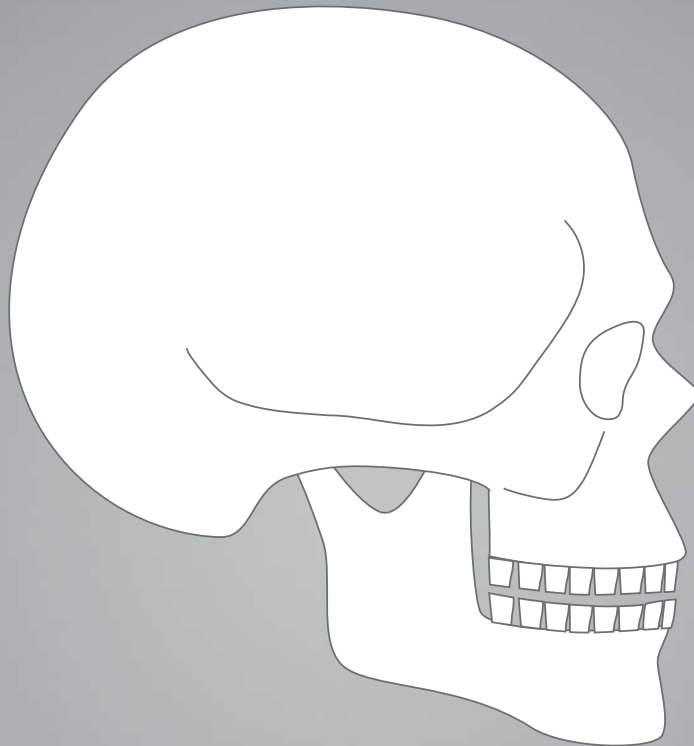

Elevatorien, Transplantatstopfer

Elevators, Graft Packers

Elevadores, Atacadores de trasplantes

Elévateurs, Poussoirs pour transplantation

Elevatori, Turatori per innesti

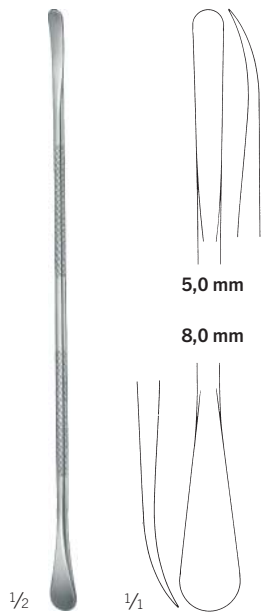

Terry
38-011-16-07

17 cm / 6 ⁵/₈"

zur Alveolarlappenabhebung
for elevation of alveolar flaps
para la elevación de las aletas alveolares
pour élévation du lambeau alvéolaire
per la elevazione del lembo alveolare

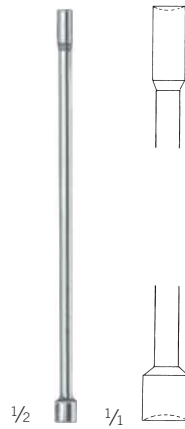

Terry
38-012-16-07

11,5 cm / 4 ¹/₈"

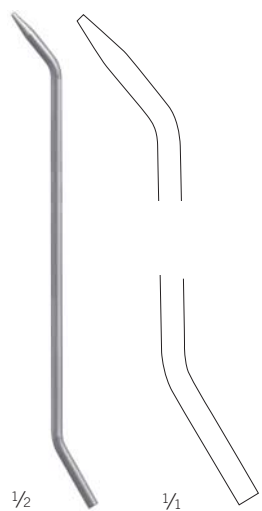

Terry
38-013-13-07

13 cm / 5 ¹/₈"



Terry
38-014-00-07

18 cm / 7 ¹/₈"

Fräser

Burrs
Fresas
Mèches
Alesatori

Kraniomaxillofaziale Chirurgie

Craniomaxillofacial surgery
Cirugía cráneo-maxilofacial
Chirurgie crânio-maxillofaciale
Chirurgia cranio-maxillofaciale

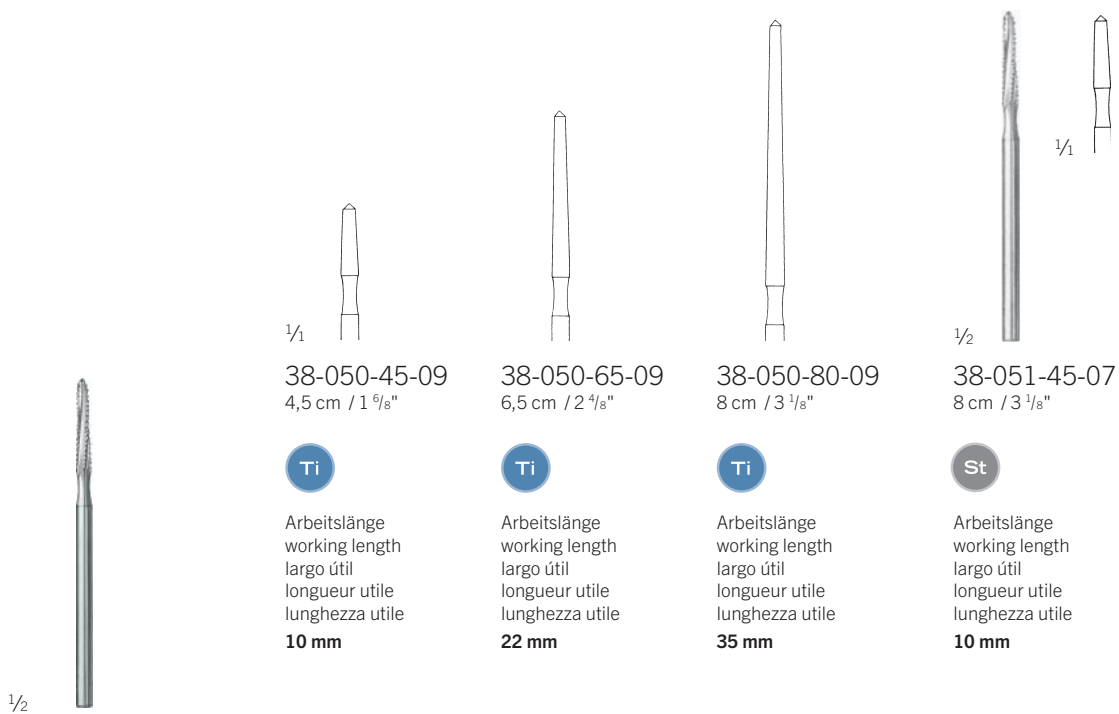

38-050-45-09
4,5 cm / 1 ⁶/₈"

Ti

Arbeitslänge
working length
largo útil
longueur utile
lunghezza utile
10 mm

38-050-65-09
6,5 cm / 2 ⁴/₈"

Ti

Arbeitslänge
working length
largo útil
longueur utile
lunghezza utile
22 mm

38-050-80-09
8 cm / 3 ¹/₈"

Ti

Arbeitslänge
working length
largo útil
longueur utile
lunghezza utile
35 mm

38-051-45-07
8 cm / 3 ¹/₈"

St

Arbeitslänge
working length
largo útil
longueur utile
lunghezza utile
10 mm

Lindemann

38-050-45-09 -

38-051-45-07

zur vertikalen Spaltung im bukkalen
Bereich des Unterkiefers

for vertical cuts in the buccal aspect
of the mandible

para cortes verticales en el aspecto
bucal de la mandíbula

pour séparation verticale dans la zone buccale
mandibulaire dans la mâchoire inférieure

per osteotomie verticali nella zona
buccale della mandibula

Mundkeile, Mundsperrer

Mouth Gags, Mouth Gags

Abrebocas, Abrebocas

Baïllons, Ouvre-bouche

Apribocca, Apribocca

Cr



1/2

Adams
38-103-01-02

Serviettenhalter
Napkin Holder
Porta-servilleta
Porte-serviettes
Porta-salvietta

Gesamtlänge
Overall length
Longitud total
Longueur totale
Lunghezza complessiva

50 cm

Cr



1/2

Langenbeck
38-111-02-02
Ø 26 / 20 mm



1/2

Maunder
38-120-10-04
9,5 cm / 3 7/8"
Holz
wood
madera
bois
legno



1/2

Pitha
38-127-02-04
Silikon
silicone
silicona
silicone
silicona

28 x 30 mm



1/1

McKesson

kunststoffbeschichteter Metallrahmen
ohne Kette
plastic coated metal frame
without chain

cuadro metálico, cubierto de plástico
sin cadena

cadre métal avec revêtement synthétique
sans chaîne

telaio metallico, ricoperto in plastica
senza catena

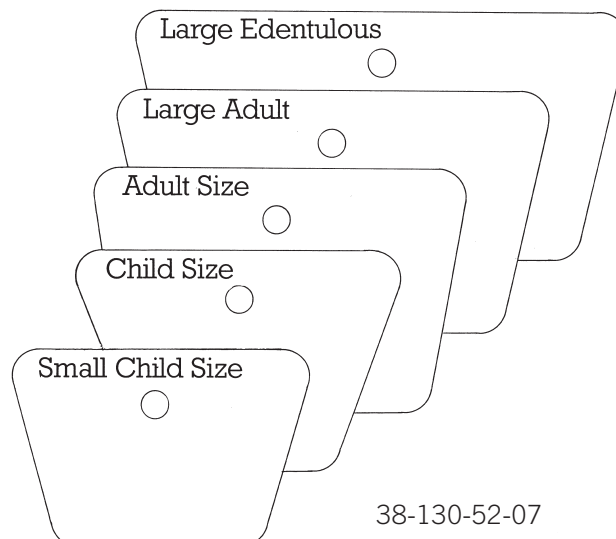

38-130-52-07
groß, für Erwachsene
large, for adults
grande, para adultos
grand, pour adultes
grande, per adulti

38-130-56-07
klein, für Kinder
small, for children
pequeño, para niños
petit, pour enfants
piccolo, per bambini

38-130-50-07
extra groß, für Zahnlose
extra large, for edentulous
muy grande, para desdentados
très grand, pour édentées
molto grande, per sdentati

38-130-54-07
normal, für Erwachsene
regular, for adults
regular, para adultos
regulier, pour adultes
regolare, per adulti

38-130-58-07
klein, für Kleinkinder
small, for babies
pequeño, para bebés
petit, pour bébés
piccolo, per neonati

38-130-90-98
Kette, allein, 18 cm
Chain, only, 18 cm
Cadena, suelto, 18 cm
Chaîne, seul, 18 cm
Catena, solo, 18 cm
18 cm

Mundsperrer

Mouth Gags
Abrebocas
Ouvre-bouche
Apribocca

Kraniomaxillofaziale Chirurgie

Craniomaxillofacial surgery
Cirugía cráneo-maxilofacial
Chirurgie crânio-maxillofaciale
Chirurgia cranio-maxillofaciale



1/2

Heister
38-140-13-07
13 cm / 5 1/8"



1/2

Molt
38-161-11-07
11 cm / 4 3/8"

38-161-93-98
Ersatzgummi
Spare Rubber
Goma de repuesto
Caoutchouc de remplacement
Gomma di ricambio



38-161-11-07



1/2

Molt
38-161-14-07
13 cm / 5 1/8"

38-161-92-98
Ersatzgummi
Spare Rubber
Goma de repuesto
Caoutchouc de remplacement
Gomma di ricambio



38-161-14-07



1/2

Denhart
38-171-12-07
13 cm / 5 1/8"

Backen
jaws
bocas
mors
branche
16 mm



1/2

Roser-König
38-179-16-07 -
38-179-20-07

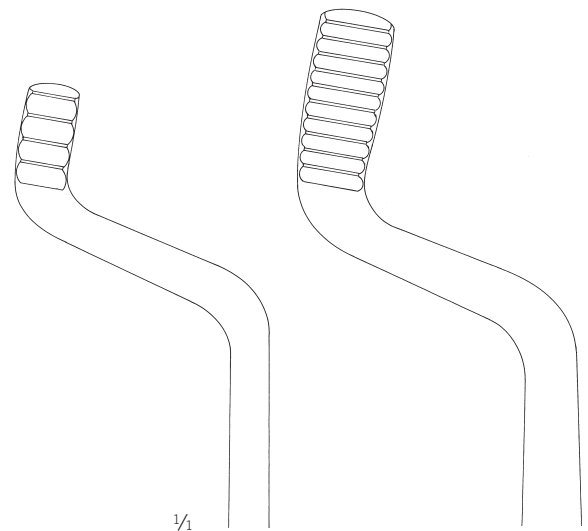

1/1

38-179-16-07
16 cm / 6 3/8"

38-179-20-07
19 cm / 7 4/8"

Mundsperrer

Mouth Gags
Abrebocas
Ouvre-bouche
Apribocca



Kilner-Doughty

38-196-00-07

Bruststütze
Chest Support
Soporte de pecho
Support contre-poitrine
Supporto per petto



38-198-00-07

Mundsperrer

Mouth Gags
Abrebocas
Ouvre-bouche
Apribocca

Kraniomaxillofaziale Chirurgie

Craniomaxillofacial surgery
Cirugía cráneo-maxilofacial
Chirurgie crânio-maxillofaciale
Chirurgia cranio-maxillofaciale



1/2



38-198-90-98

Gaumenplatte
Palate Plate
Plaquita paldia
Plaque platine
Placca per palato

Kilner-Doughty
38-198-00-07

komplett mit Rahmen, 3 Zungenspatel, 2 Zahnplatten und 1 Gaumenplatte
complete, with frame, 3 tongue depressors, 2 toothplates and 1 palate plate
completo con bastidor, 3 bajalenguas, 2 plaquitas de dientes y 1 plaquita paldia
complet avec cadre, 3 abaisse-langue, 2 plaques pour dents e 1 plaque palatine
completo, con telaio, 3 abassalingua, 2 placche per denti e 1 placca per palato

Kilner-Doughty
38-198-10-07

14,5 cm / 5 7/8"
Mundsperrer-Rahmen
Frame for Mouth Gag
Bastidor para abreboca
Cadre pour ouvre-bouche
Telaio per apribocca

➔ 38-198-00-07

Kilner-Doughty
38-198-01-07 -
38-198-03-07

Zungendrucker
Tongue Depressor
Bajalengua
Abaisse-langue
Abassalingua

gefenestertes Blatt für Absaugung
fenestrated blade for suction
hoja fenestrada para succión
lame fenêtrée pour aspiration
lama con finestra per aspirazione



1/2

Fig. 1
38-198-01-07
68 x 30 mm



Fig. 2
38-198-02-07
77 x 34 mm



Fig. 3
38-198-03-07
82 x 39 mm

➔ 38-198-00-07

Mundsperrer

Mouth Gags
Abrebocas
Ouvre-bouche
Apribocca



1/2

Neukam
38-208-00-07

komplett mit Rahmen und 3 Zungendrücker
complete, with frame and 3 tongue depressors
completo con bastidor y 3 bajalenguas
complet avec cadre et 3 abaisse-langue
completo, con telaio e 3 abassalingua

Neukam
38-208-10-07

Mundsperrer-Rahmen, allein
Frame for Mouth Gag, only
Bastidor para abreboca, suelto
Cadre pour ouvre-bouche, seul
Telaio per apribocca, solo



38-208-00-07

65 x 25,5 mm



73 x 28,5 mm



71 x 30,0 mm



1/2



38-208-01-07 -
38-208-03-07

Zungendrücker
Tongue Depressor
Bajalengua
Abaisse-langue
Abassalingua

gefenestertes Blatt für Absaugung
fenestrated blade for suction
hoja fenestrada para succión
lame fenêtrée pour aspiration
lama con finestra per aspirazione



38-208-00-07

Fig. 1
38-208-01-07

Fig. 2
38-208-02-07

Fig. 3
38-208-03-07

Mundsperrer

Mouth Gags
Abrebocas
Ouvre-bouche
Apribocca

Kraniomaxillofaziale Chirurgie

Craniomaxillofacial surgery
Cirugía cráneo-maxilofacial
Chirurgie crânio-maxillofaciale
Chirurgia cranio-maxillofaciale



Davis-Boyle

38-212-00-07

komplett, bestehend aus Rahmen und fünf Zungendrückern Fig. 1 - 5
complete, consisting of frame and 5 tongue depressors no. 1 -5
completo, consiste de bastidor y 5 bajalenguas no. 1 - 5
complet, se composant de cadre e 5 abaisse-langue no. 1 - 5
completo, composto di telaio e 5 abassalingua no. 1 - 5

38-212-10-07

Mundsperrer-Rahmen
Frame for Mouth Gag
Bastidor para abrebooca
Cadre pour ouvre-bouche
Telaio per apribocca



38-212-00-07

38-212-50-07

Mundsperrer-Rahmen mit Gelenk
Frame for Mouth Gag with joint
Bastidor para abrebooca con articulación
Cadre pour ouvre-bouche avec joint articulé
Telaio per apribocca con snodo

38-212-90-98

Silikoneinlage
Silicone inlay
Plaquita de silicona
Plaque de silicone
Stuoia in silicone



38-212-50-07



38-212-01-07 -
38-212-05-07

mit fester Absaugung
with fixed suction tube
con tubo de succión fijo
avec tube d'aspiration fixée
con tubo di aspirazione fisso



38-212-00-07

1/2

Fig. 1
38-212-01-07
110 x 26 mm



Fig. 2
38-212-02-07
95 x 25 mm



Fig. 3
38-212-03-07
85 x 24 mm



Fig. 4
38-212-04-07
70 x 23 mm



Fig. 5
38-212-05-07
30 x 20 mm

ohne Absaugung
without suction tube
sin tubo de succión fijo
sans tube d'aspiration fixée
senza tubo di aspirazione fisso

Mundsperrer

Mouth Gags
Abrebocas
Ouvre-bouche
Apribocca



Mclvor
38-222-00-07

komplett, mit 3 Zungendrucker
complete, with 3 tongue depressors
completo, con 3 bajalenguas
complet, avec 3 abaisse-langue
completo, con 3 abassalingua

Mclvor
38-222-10-07

Mundsperrer-Rahmen
Frame for Mouth Gag
Bastidor para abreboca
Cadre pour ouvre-bouche
Telaio per apribocca



Mclvor
38-222-01-07 -
38-222-03-07

Zungendrucker
Tongue Depressor
Bajalengua
Abaisse-langue
Abassalingua



Fig. 1
38-222-01-07
100 x 25 mm



Fig. 2
38-222-02-07
85 x 25 mm



Fig. 3
38-222-03-07
75 x 25 mm

Mundsperrer

Mouth Gags
Abrebocas
Ouvre-bouche
Apribocca

Kraniomaxillofaziale Chirurgie

Craniomaxillofacial surgery
Cirugía cráneo-maxilofacial
Chirurgie crânio-maxillofaciale
Chirurgia cranio-maxillofaciale

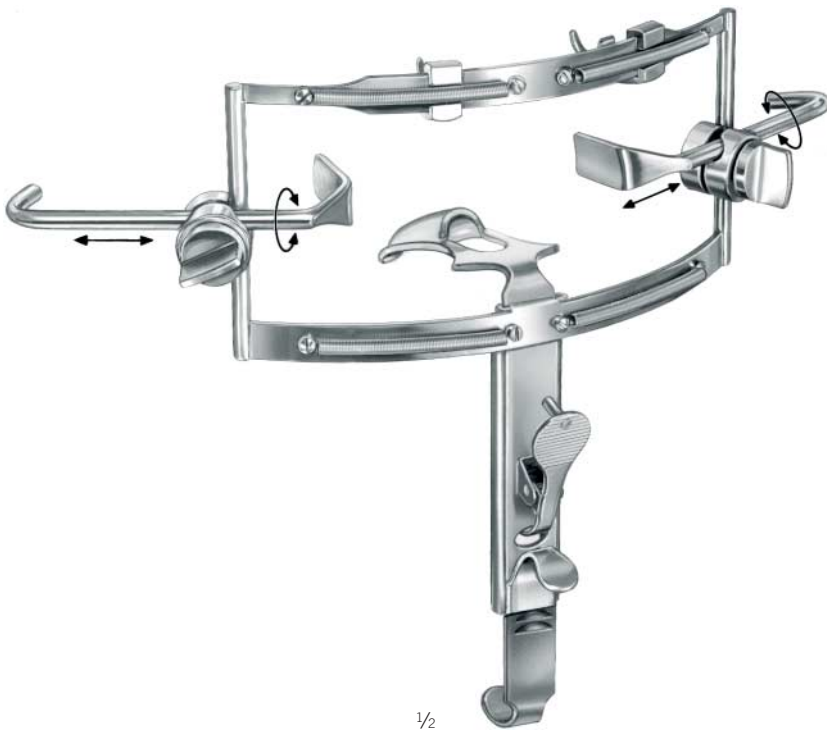

Dingmann
38-224-00-07

komplett mit Rahmen, 3 Zungendrückern
und 2 beweglichen Seitenvälven
complete, with frame, 3 tongue depressors
and 2 adjustable lateral blades
completo con bastidor, 3 bajalenguas
y 2 valvas laterales ajustables
complet avec cadre, 3 abaisse-langue
et 2 valves latérales réglables
completo, con telaio, 3 abassalingua
e 2 valve laterali movibili

Dingmann
38-224-01-07 -
38-224-03-07

Zungendrücker
Tongue Depressor
Bajalengua
Abaisse-langue
Abassalingua

➔ 38-224-00-07



Fig. 1
38-224-01-07
62 x 26 mm

Fig. 2
38-224-02-07
65 x 30 mm

Fig. 3
38-224-03-07
78 x 32 mm

Mundsperrer, Lippen- und Wangenhalter

Mouth Gags, Lip and Cheek Retractors
 Abrebocas, Separadores para labios y mejillas
 Ouvre-bouche, Ecarteurs des lèvres et joues
 Apribocca, Separatori per labbra e guancia



1/2

Jennings
 38-237-09-07 -
 38-237-15-07

38-237-09-07	10,5 cm / 4 1/8"
38-237-11-07	12,5 cm / 4 7/8"
38-237-13-07	14,5 cm / 5 6/8"
38-237-15-07	16,5 cm / 6 4/8"



1/2

Oringer
 38-240-00-07
 9,5 cm / 3 6/8"
 selbsthaltend, für Kinder
 self retaining, for children
 autoestático, para niños
 autostatique, pour enfants
 autostatico, per bambini

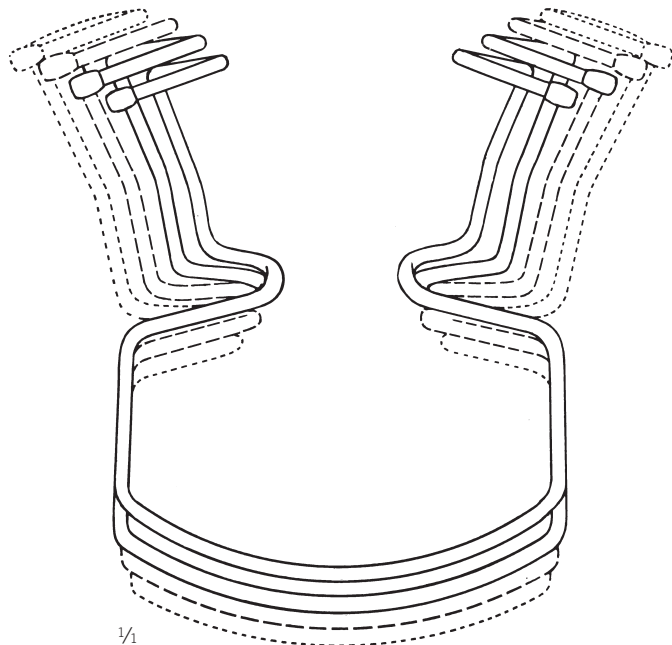

1/1

Fig. 1	38-240-01-07	10 cm / 3 7/8"
Fig. 2	38-240-02-07	10,5 cm / 4 1/8"
Fig. 3	38-240-03-07	11 cm / 4 3/8"

38-240-13-07

selbsthaltend	Satz mit Fig. 1-3
self retaining	set with no. 1-3
autoestático	juego de no. 1-3
autostatique	jeu de no. 1-3
autostatico	set con no. 1-3

Lippen- und Wangenhalter

Lip and Cheek Retractors
Separadores para labios y mejillas
Ecarteurs des lèvres et joues
Separatori per labbra e guancia

Kraniomaxillofaziale Chirurgie

Craniomaxillofacial surgery
Cirugía cráneo-maxilofacial
Chirurgie crânio-maxillofaciale
Chirurgia cranio-maxillofaciale



48 mm



1/2

Martin-Simplex
38-243-11-01
10,5 cm / 4 1/8"

80 mm



1/2

38-246-14-04
14 cm / 5 4/8"
Vestibulumhaken
Vestibulum Retractor
Separador para vestibulo
Ecarteur pour vestibulum
Separatore per vestibulo

26 mm



1/2

37 mm

Sternberg
38-249-14-01
14 cm / 5 4/8"



1/2

Obwegeser
38-251-12-07
12 cm / 4 6/8"

20 mm



1/2

Bishop
38-261-13-01
13,5 cm / 5 3/8"



1/2

Cawood-Minnesota
38-263-15-01
15,5 cm / 6 1/8"



1/2

Cawood-Minnesota
38-265-00-01
14,5 cm / 5 6/8"



1/2

Zungendrucker

Tongue Depressors

Abajalenguas

Abaisse-langue

Abassalingua



Hartmann
38-271-15-07
15 cm / 5 7/8"



Tobold
38-277-14-07
15 cm / 5 7/8"



Tobold
38-281-14-07
16 cm / 6 2/8"



Wieder
38-297-01-01 -
38-297-02-01

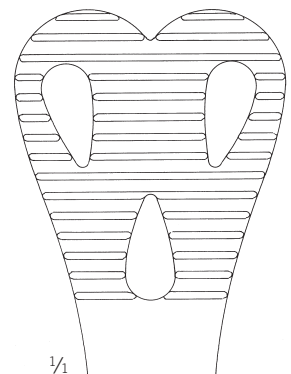
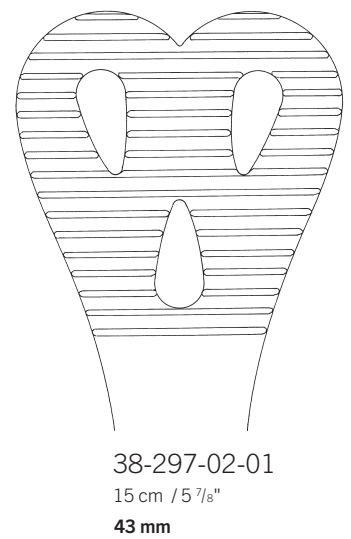

Zungenspatel

Tongue Spatulas
Espátulas linguales
Abaisse-langue
Spatole per lingua

Kraniomaxillofaziale Chirurgie

Craniomaxillofacial surgery
Cirugía cráneo-maxilofacial
Chirurgie crânio-maxillofaciale
Chirurgia cranio-maxillofaciale

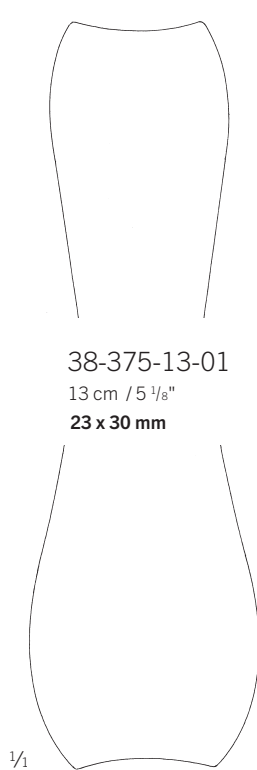

Doyen
38-375-13-01 -
38-375-16-01

Brünings
38-385-19-01
19 cm / 7 4/8"

Lip And Cheek Retractors

Lip And Cheek Retractors

Lip And Cheek Retractors

Lip And Cheek Retractors

Lip And Cheek Retractors

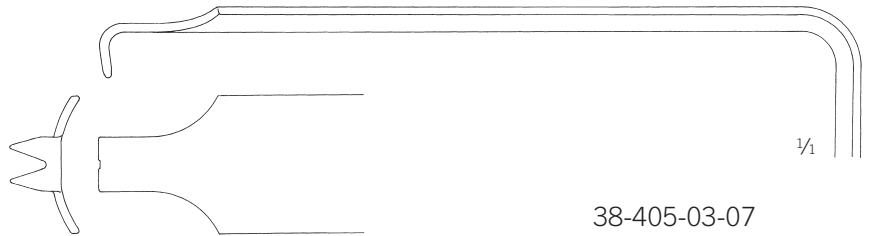
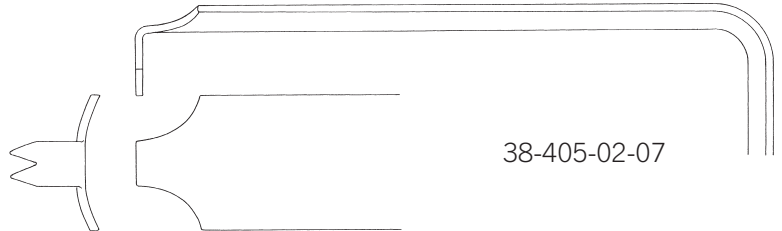

Austin
38-405-02-07 -
38-405-03-07
16 cm / 6 $\frac{2}{8}$ "

Zungenzangen

Tongue Holding Forceps

Pinzas tira-lengua

Pinces tire-langue

Pinze per lingua

Kraniomaxillofaziale Chirurgie

Craniomaxillofacial surgery

Cirurgía cráneo-maxilofacial

Chirurgie crânio-maxillofaciale

Chirurgia cranio-maxillofaciale



1/2

Collin
38-452-17-07
17 cm / 6 5/8"



1/2

Young
38-467-17-07
15 cm / 5 7/8"

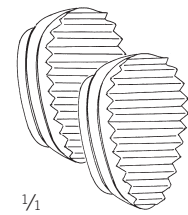

1/1

Young
38-468-02-04
Gummipolster
Rubber Inserts
Bocas de goma
Mors en caoutchouc
Cuscino di gomma

Paar
pair
par
paire
paio



38-467-17-07

Intraorale Retraktoren

Intra Oral Retractors
Separadores intra orales
Rétracteurs intra-oraux
Separatori intraorali

9,5/16 mm



38-501-24-01

22 cm / 8⁷/₈"

konkav, stark aufgebogen
concave, fully bent tip
concave, courbé énormément
conzáva, fuertemente curva
concava, fortemente curva



Eckelt

38-502-24-01

21 cm / 8²/₈"

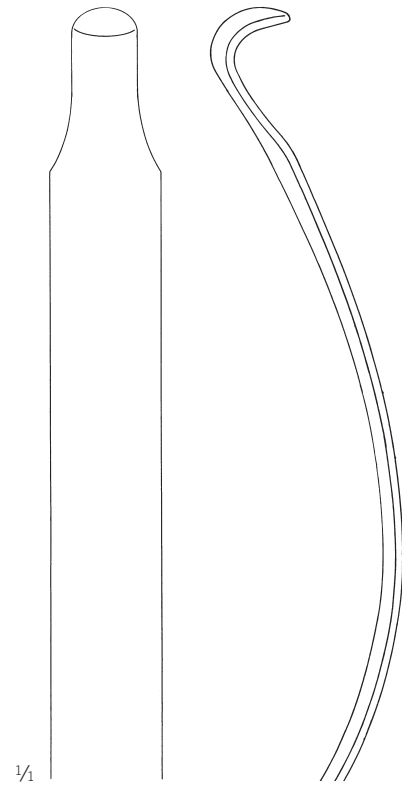

Intraorale Retraktoren

Intra Oral Retractors
Separadores intra orales
Rétracteurs intra-oraux
Separatori intraorali

Kraniomaxillofaziale Chirurgie

Craniomaxillofacial surgery
Cirugía cráneo-maxilofacial
Chirurgie crânio-maxillofaciale
Chirurgia cranio-maxillofaciale



9,5/16 mm



38-503-27-01

25 cm / 9 7/8"

konkav, stark aufgebogen
concave, fully bent tip
concáva, fuertemente curva
concave, courbé énormément
concava, fortemente curva



Eckelt

38-504-27-01

25 cm / 9 7/8"

konkav, stark aufgebogen
concave, fully bent tip
concáva, fuertemente curva
concave, courbé énormément
concava, fortemente curva

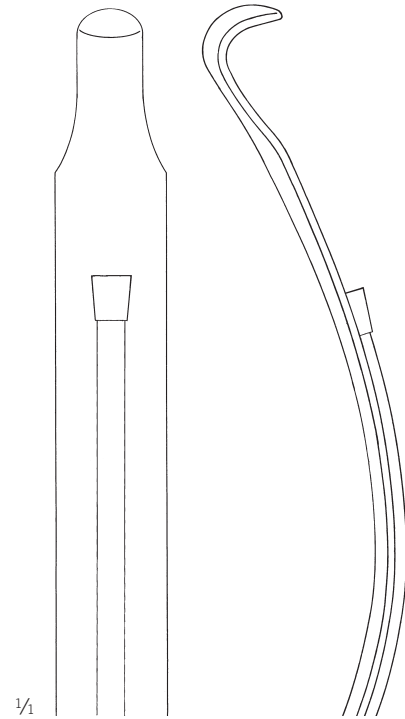

Intraorale Retraktoren

Intra Oral Retractors
Separadores intra orales
Rétracteurs intra-oraux
Separatori intraorali



38-505-24-01

23 cm / 9"

für LeFort Osteotomie
for LeFort osteotomies
para osteotomías según LeFort
pour ostéotomie selon LeFort
per osteotomie sec. LeFort
25,5 mm



38-507-27-01

26 cm / 10 2/8"

für LeFort Osteotomie
for LeFort osteotomies
para osteotomías según LeFort
pour ostéotomie selon LeFort
per osteotomie sec. LeFort
25,5 mm

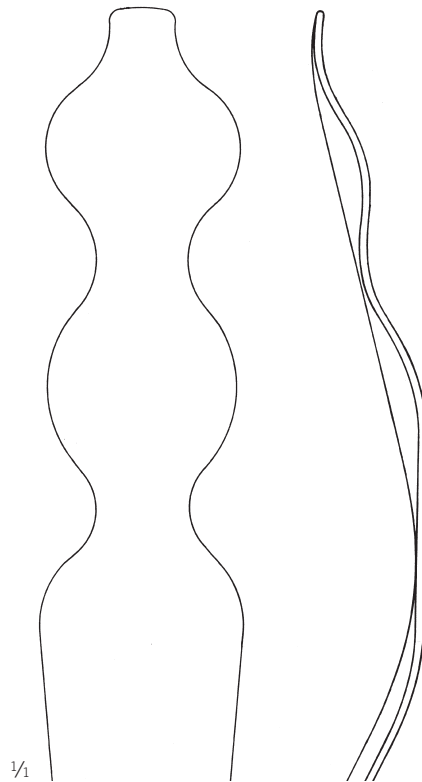

Intraorale Retraktoren

Intra Oral Retractors
Separadores intra-orales
Rétracteurs intra-oraux
Separatori intraorali

Kraniomaxillofaziale Chirurgie

Craniomaxillofacial surgery
Cirugía cráneo-maxilofacial
Chirurgie crânio-maxillofaciale
Chirurgia cranio-maxillofaciale

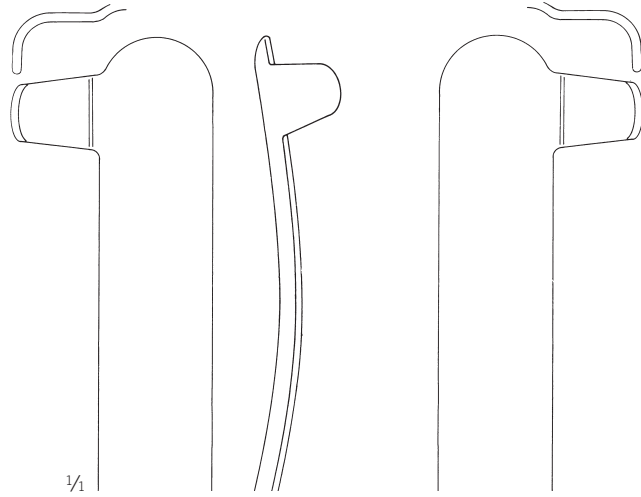

26,5 / 16 mm

26,5 / 16 mm

26,5 / 16 mm

26,5 / 16 mm



1/2

1/2

1/2

1/2

38-509-21-01

21 cm / 8 2/8"

rechts
right
derecho
droit
destra

38-511-21-01

21 cm / 8 2/8"

links
left
izquierdo
gauche
sinistra

38-513-24-01

24,5 cm / 9 5/8"

rechts
right
derecho
droit
destra



38-515-24-01

24,5 cm / 9 5/8"

links
left
izquierdo
gauche
sinistra



Intraorale Retraktoren

Intra Oral Retractors

Separadores intra-orales

Rétracteurs intra-oraux

Separatori intraorali

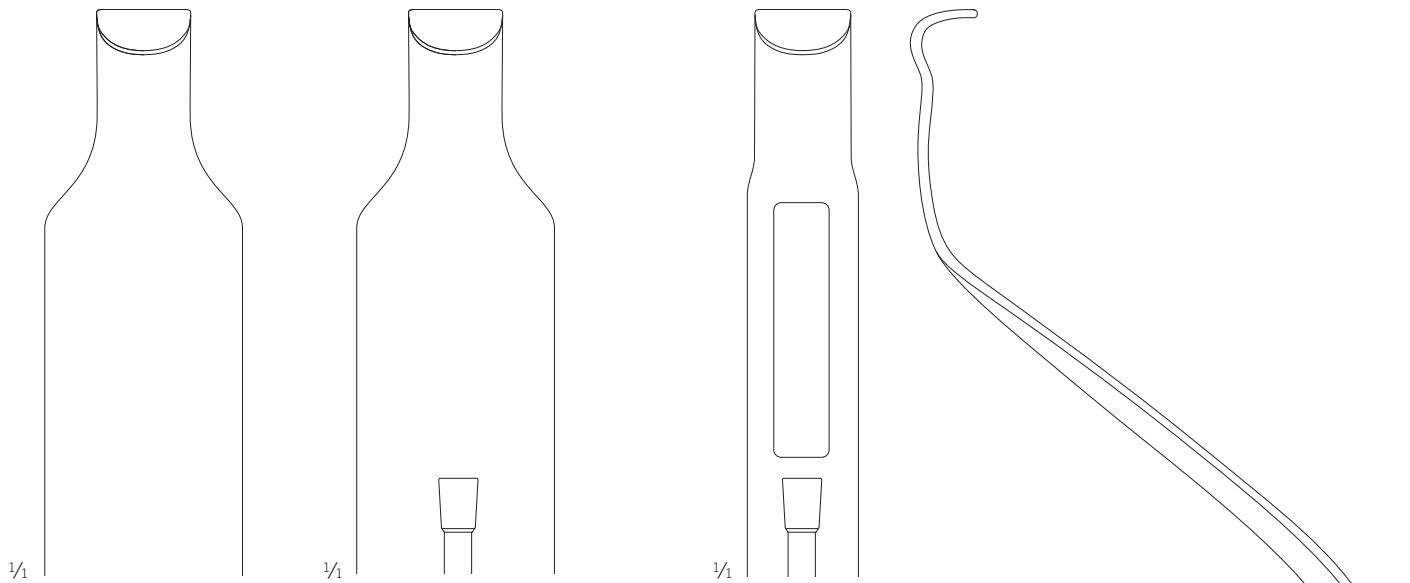

12,5 / 27 mm

12,5 / 27 mm

12,5 / 27 mm



1/2

38-517-25-01

25 cm / 9 7/8"

L&M, für vertikale Osteotomie
L&M for vertical osteotomy
L&M, para osteotomía vertical
L&M, pour ostéotomie verticale
L&M, per osteotomia verticale



1/2

38-519-28-01

28 cm / 11"

L&M, für vertikale Osteotomie
L&M for vertical osteotomy
L&M, para osteotomía vertical
L&M, pour ostéotomie verticale
L&M, per osteotomia verticale



1/2

38-520-28-01

28 cm / 11"

L&M, für vertikale Osteotomie, gefenestert
L&M for vertical osteotomy, fenestrated
L&M, para osteotomía vertical, fenestrada
L&M, pour ostéotomie verticale, fenêtrée
L&M, per osteotomia verticale, finestra



1/1

Intraorale Retraktoren

Intra Oral Retractors
Separadores intra-orales
Rétracteurs intra-oraux
Separatori intraorali

Kraniomaxillofaziale Chirurgie

Craniomaxillofacial surgery
Cirugía cráneo-maxilofacial
Chirurgie crânio-maxillofaciale
Chirurgia cranio-maxillofaciale

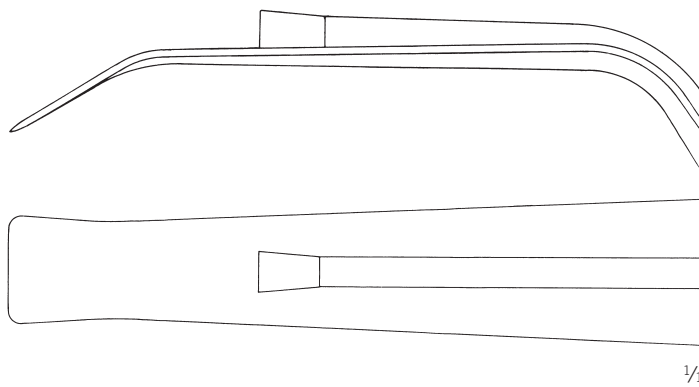

14,5 mm



Shea
38-523-24-01

23,5 cm / 9 2/8"

Mehrzweck-Retraktor
Multi purpose Retractor
Separador de aplicaciones varias
Rétracteur pour applications différentes
Separatore multiuso



Sagittale Ramusosteotomie nach Ishi

Sagittal ramus osteotomies acc. to Ishi
Osteotomía sagital de rama mandibular según Ishi
Ostéotomie sagittale du ramus selon Ishi
Osteotomia sagittale del ramo secondo Ishi

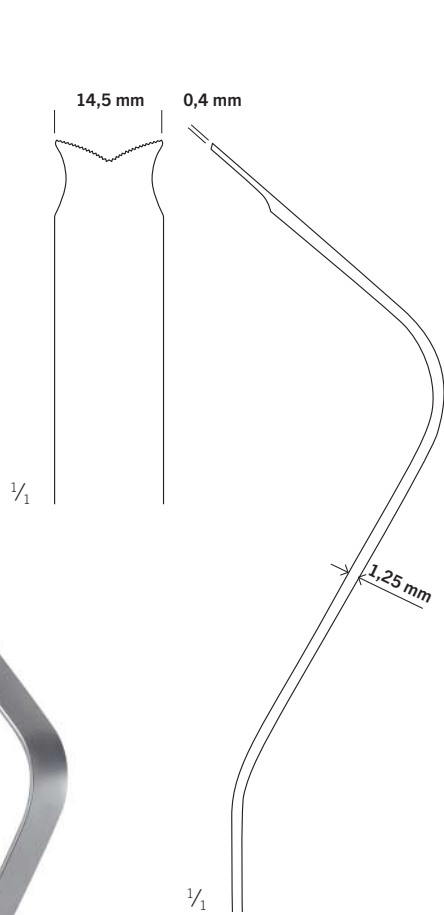

1/2

Ishi
38-520-01-07
23 cm / 9"

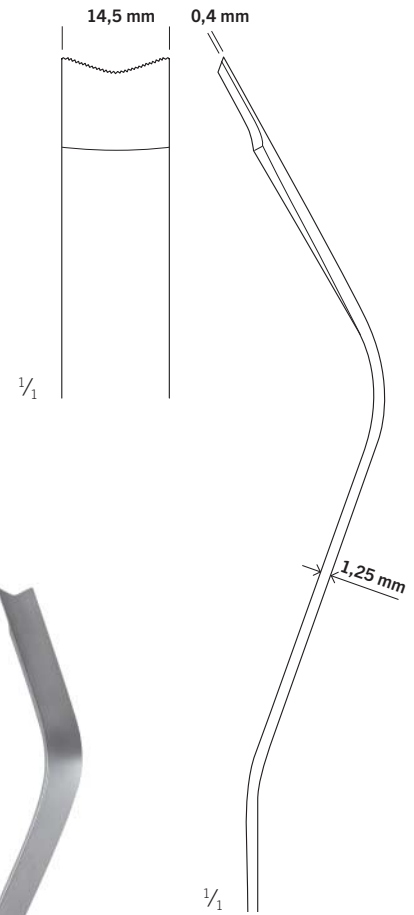

1/2

Ishi
38-520-02-07
24,5 cm / 9 5/8"

Sagittale Ramusosteotomie nach Ishi

Sagittal ramus osteotomies acc. to Ishi
Osteotomía sagital de rama mandibular según Ishi
Ostéotomie sagittale du ramus selon Ishi
Osteotomia sagittale del ramo secondo Ishi

Kraniomaxillofaziale Chirurgie

Craniomaxillofacial surgery
Cirugía cráneo-maxilofacial
Chirurgie crânio-maxillofaciale
Chirurgia cranio-maxillofaciale

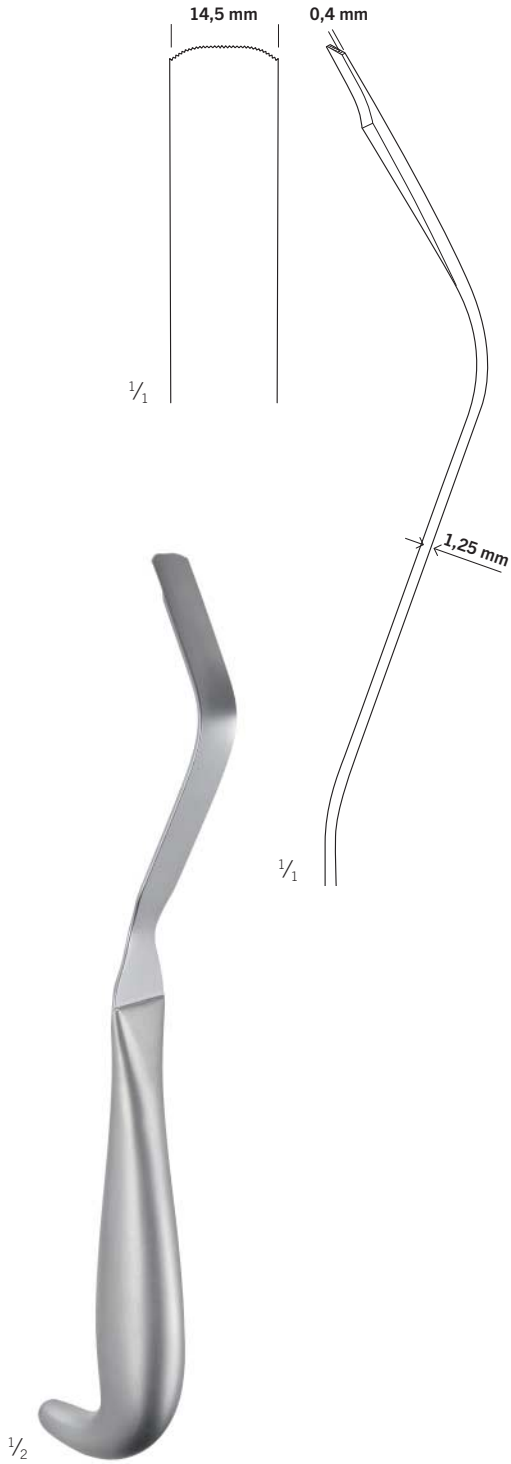

Ishi
38-520-03-07
24 cm / 9 4/8"



Ishi
38-520-04-07
19,5 cm / 7 5/8"

Intraorale Retraktoren

Intra Oral Retractors

Separadores intra-orales

Rétracteurs intra-oraux

Separatori intraorali

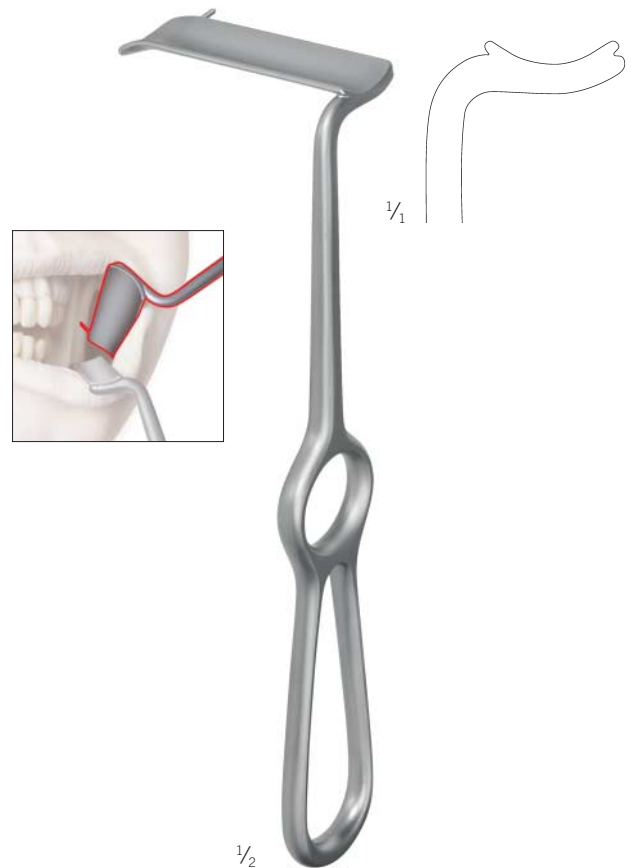
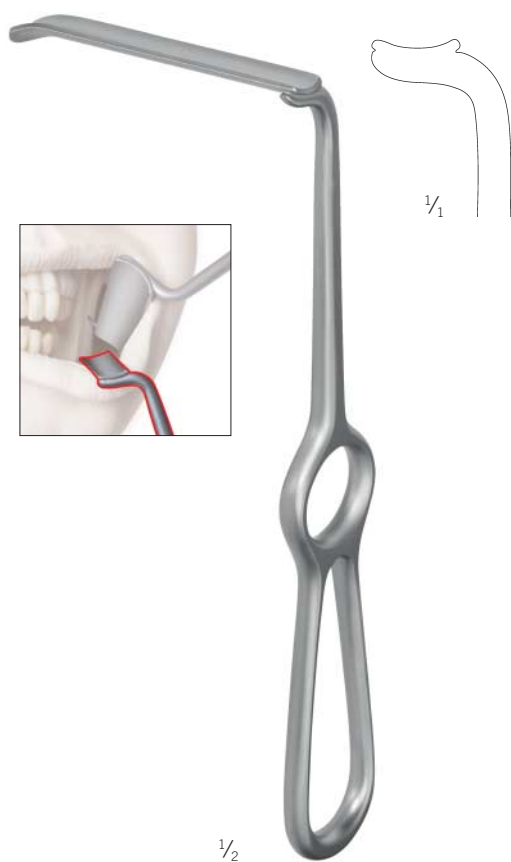
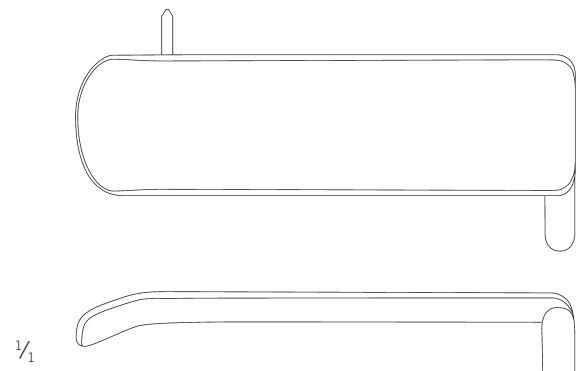
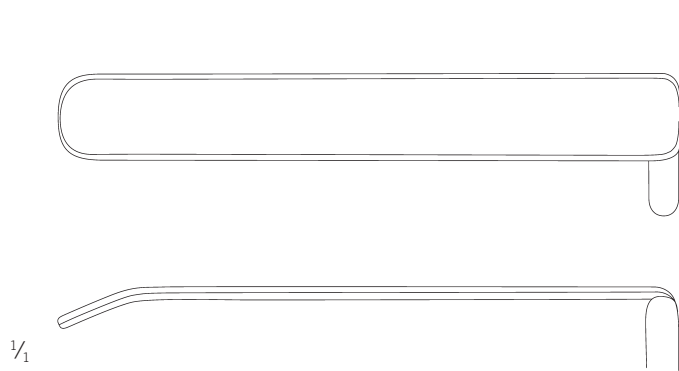

Lindorf
38-525-01-07
19,5 cm / 7 5/8"

Side-Step-Haken, links unten
Side-step retractor, left-side, lower region
Side-step retractor, left-side, lower region
Separador tipo "side-step", lado izquierdo, región inferior
Rétracteur «side-step», côté gauche, région inférieure
Retrattore "side-step", lato sinistro, regione inferiore

Lindorf
38-526-01-07
19,5 cm / 7 5/8"

Ramus-Krallenhaken, links oben
Hook-type ramus retractor, left-side, upper region
Separador de rama mandibular tipo garra, lado izquierdo, región superior
Rétracteur à crochet pour ramus, côté gauche, région supérieure
Retrattore ad uncino per ramo, lato sinistro, regione superiore

Intraorale Retraktoren

Intra Oral Retractors
 Separadores intra orales
 Rétracteurs intra-oraux
 Separatori intraorali

Kraniomaxillofaziale Chirurgie

Craniomaxillofacial surgery
 Cirugía cráneo-maxilofacial
 Chirurgie crânio-maxillofaciale
 Chirurgia cranio-maxillofaciale

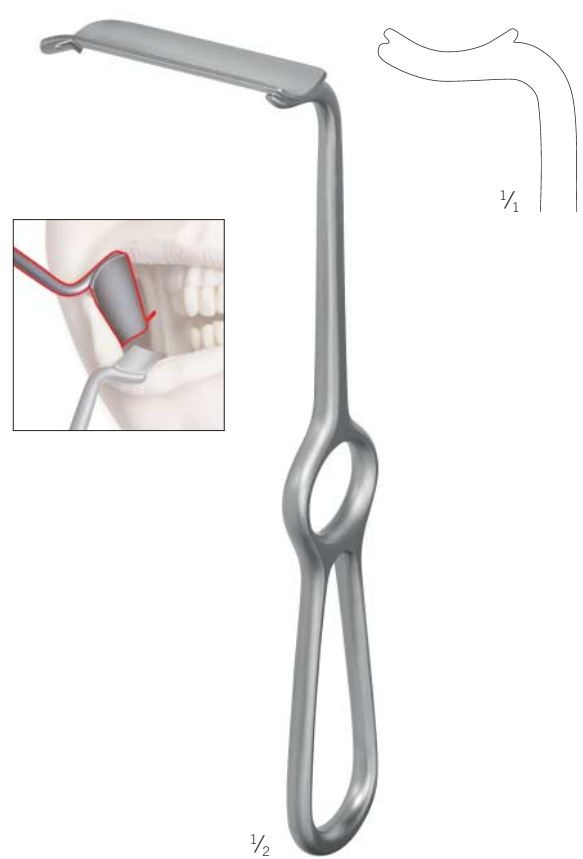
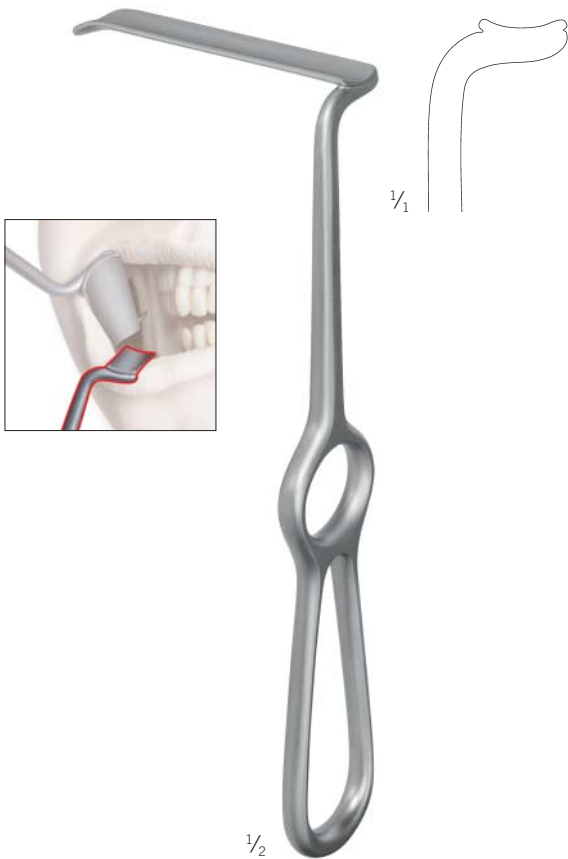
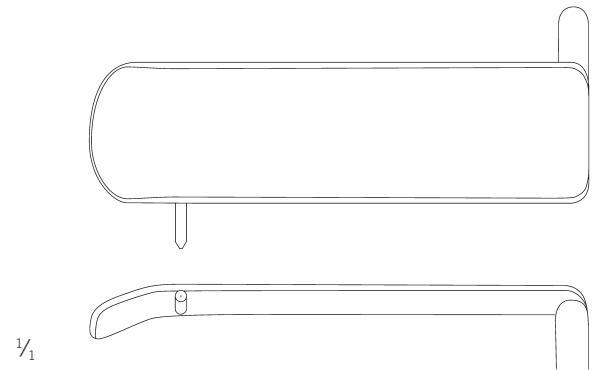
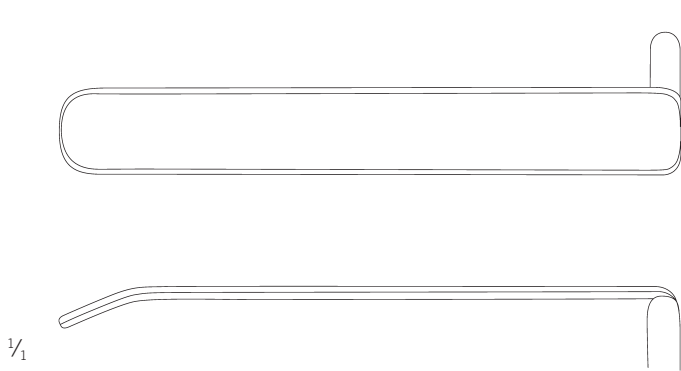

Lindorf
 38-525-02-07
 19,5 cm / 7 5/8"

Side-Step-Haken, rechts unten
 Side-step retractor, right-side, lower region
 Separador tipo "side-step", lado derecho, región inferior
 Rétracteur «side-step», côté droit, région inférieure
 Retrattore "side-step", lato destro, regione inferiore

Lindorf
 38-526-02-07
 19,5 cm / 7 5/8"

Ramus-Krallenhaken, rechts oben
 Hook-type ramus retractor, right-side, upper region
 Separador de rama mandibular tipo garra,
 lado derecho, región superior
 Rétracteur à crochet pour ramus, côté droit,
 région supérieure
 Retrattore ad uncino per ramo, lato destro,
 regione superiore

Sinus-Krallenhaken nach Lindorf

Sinus-Krallenhaken acc. to Lindorf

Separador-garra sinus según Lindorf

Retracteur sinus griffe selon Lindorf

Divaricatore-artiglio sinus secondo Lindorf



Lindorf
38-527-01-07

19,5 cm / 7 5/8"

Sinus-Krallenhaken, links
Sinus claw retractor, left
Separador-garra sinus, izquierda
Retracteur sinus griffe, gauche
Divaricatore-artiglio sinus, sinistra



Lindorf
38-527-02-07

19,5 cm / 7 5/8"

Sinus-Krallenhaken, rechts
Sinus claw retractor, right
Separador-garra sinus, derecha
Retracteur sinus griffe, droite
Divaricatore-artiglio sinus, destra

Weichteilhaken

Soft Tissue Retractors
Separadores para partes blandas
Crochets pour parties molles
Separatori per tessuti molli

Kraniomaxillofaziale Chirurgie

Craniomaxillofacial surgery
Cirugía cráneo-maxilofacial
Chirurgie crânio-maxillofaciale
Chirurgia cranio-maxillofaciale

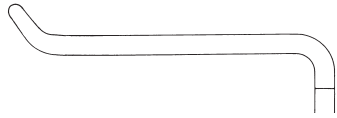

38-603-40-07

22,5 cm / 8 7/8"

43 x 11 mm

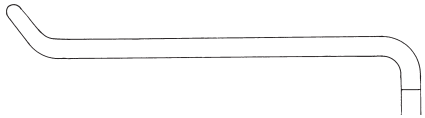

38-603-55-07

23 cm / 9"

57 x 11 mm

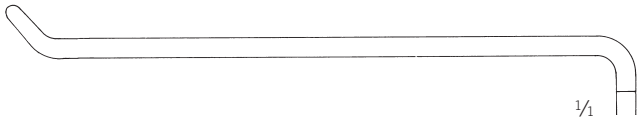

38-603-80-07

23 cm / 9"

80 x 16 mm

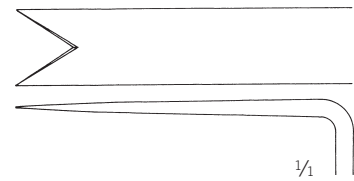

43 x 10 mm



1/2

Obwegeser
38-603-40-07 -
38-603-80-07



1/2

Obwegeser
38-605-22-07
22 cm / 8 5/8"

Spina nasalis-Haken
Nasal Spine Retractor
Separador para spina nasalis
Ecarteur pour spina nasalis
Separatore per spina nasale

Ramushaken, Kinnhalter, Progenierinnen

Ramus Retractors, Chin Retractor, Channel Retractors

Separadores para el ramo, Gancho de mentón, Separadores mandibulares

Ecarteurs pour ramus, Fixe-menton, Ecarteurs mandibulaires

Separatore per ramo, Guancio per mento, Separatori mandibulari

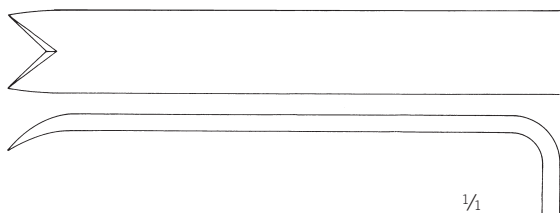

72 x 10 mm



1/2

Obwegeser
38-607-22-07
22 cm / 8 5/8"



1/2

Obwegeser
38-611-16-07
16,5 cm / 6 4/8"



1/2

Obwegeser
38-613-08-07 -
38-613-10-07

38-613-08-07
16 cm / 6 2/8"
8 mm

38-613-10-07
16 cm / 6 2/8"
10 mm

Progeniehaken

Progeny Retractor
Separadores para progenismo
Crochets de progenie
Separatori per progenismo

Kraniomaxillofaziale Chirurgie

Craniomaxillofacial surgery
Cirugía cráneo-maxilofacial
Chirurgie crânio-maxillofaciale
Chirurgia cranio-maxillofaciale

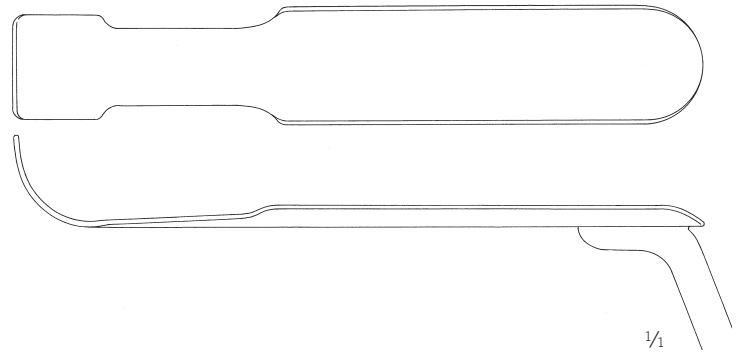
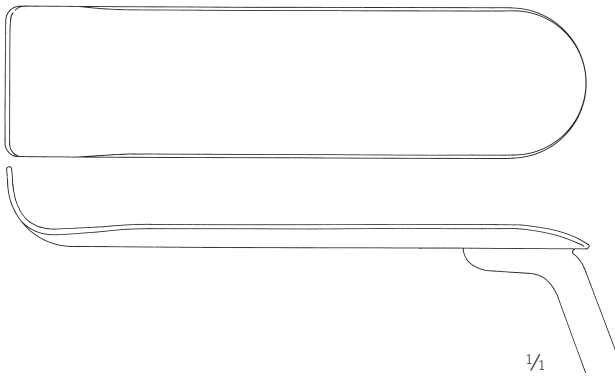

Schuchardt
38-614-10-07
18 cm / 7 1/8"



Metz
38-614-20-07
19,5 cm / 7 5/8"

Wundhaken

Retractors
Separadores
Ecarteurs
Divaricatori



38-616-01-07 -
38-616-02-07
18 cm / 7 1/8"

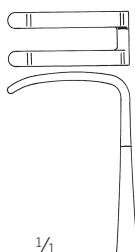

Koberg
38-616-01-07
15 x 7 mm

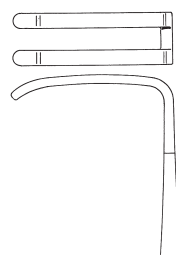

Koberg, mod.
38-616-02-07
20 x 7 mm

Progeniehaken

Progeny Retractor
Separadores para progenismo
Crochets de progenie
Separatori per progenismo

Kraniomaxillofaziale Chirurgie

Craniomaxillofacial surgery
Cirugía cráneo-maxilofacial
Chirurgie crânio-maxillofaciale
Chirurgia cranio-maxillofaciale

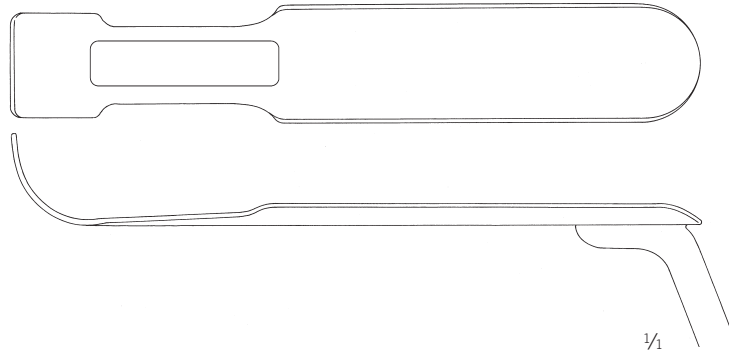
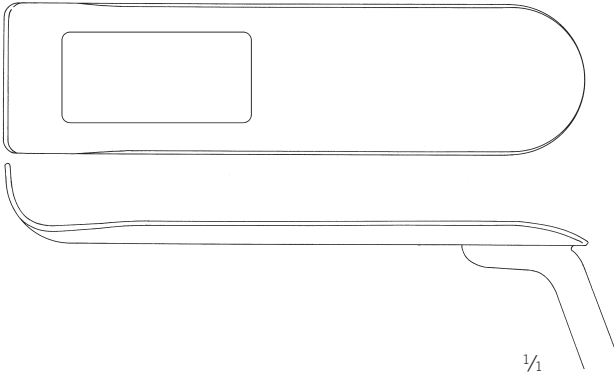

1/2

Schuchardt-Lauer
38-616-10-07
15 cm / 5 7/8"



1/2

Metz-Lauer
38-616-20-07
15 cm / 5 7/8"

Raspatorien

Periosteal Elevators

Legras

Rugines-raspatoires

Elevatori per periosteo

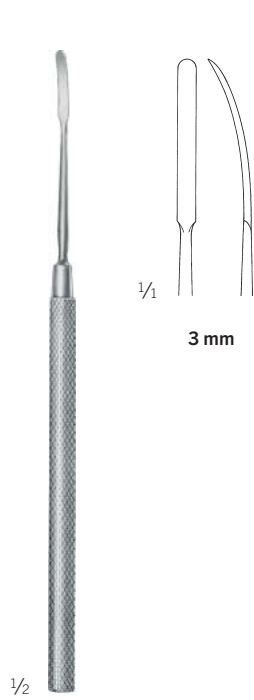

38-618-01-07

18 cm / 7 1/8"

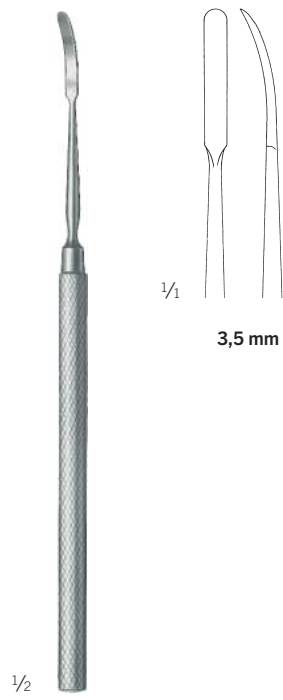

38-618-02-07

18 cm / 7 1/8"

Progeniehaken

Progeny Retractor
Separadores para progenismo
Crochets de progenie
Separatori per progenismo

Kraniomaxillofaziale Chirurgie

Craniomaxillofacial surgery
Cirugía cráneo-maxilofacial
Chirurgie crânio-maxillofaciale
Chirurgia cranio-maxillofaciale

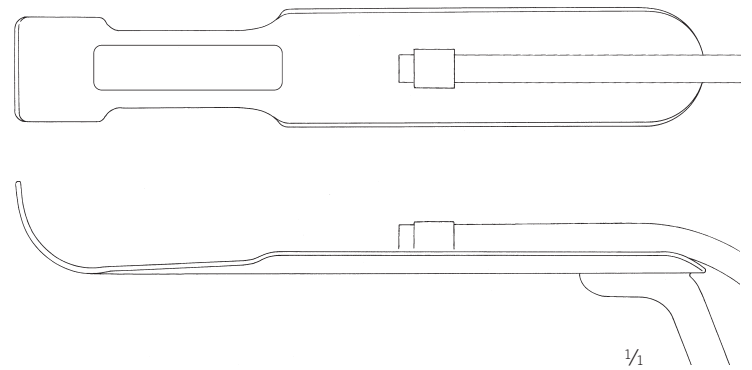
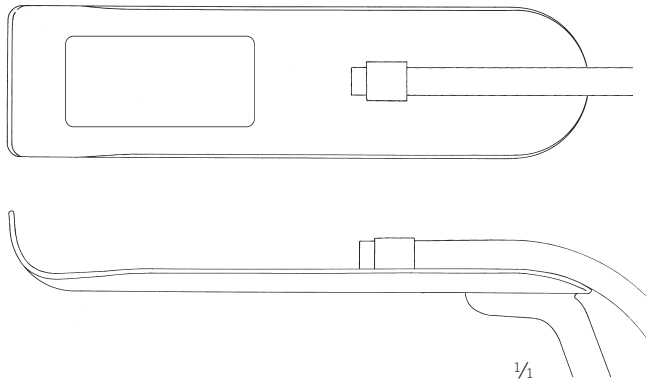

1/2

Schuchardt-Lauer
38-618-10-07
15 cm / 5 7/8"



1/2

Metz-Lauer
38-618-20-07
15 cm / 5 7/8"



Progeniehaken

Progeny Retractor

Separadores para progenismo

Crochets de progenie

Separatori per progenismo

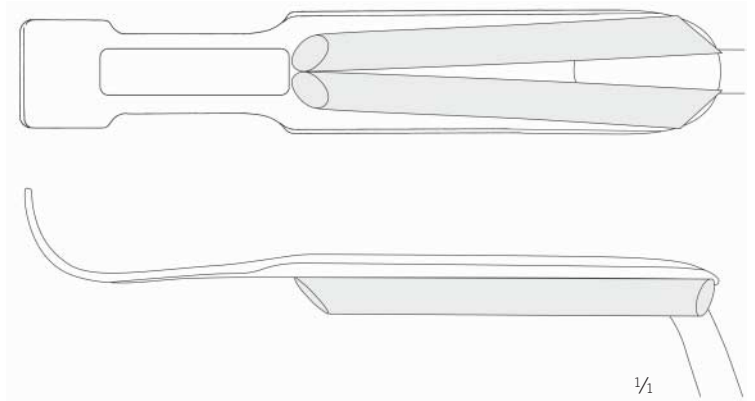
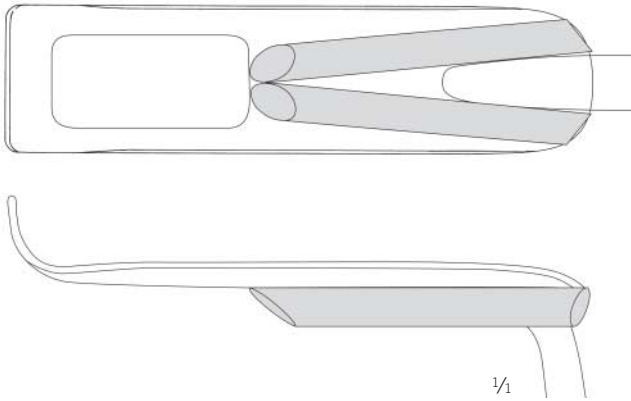

Schuchardt-Lauer
38-620-10-07
20 cm / 7 7/8"



Metz-Lauer
38-620-20-07
20 cm / 7 7/8"

Raspatorien

Periosteal Elevators
Periostótomos
Rugines-raspatoires
Periostotomi

Kraniomaxillofaziale Chirurgie

Craniomaxillofacial surgery
Cirugía cráneo-maxilofacial
Chirurgie crânio-maxillofaciale
Chirurgia cranio-maxillofaciale

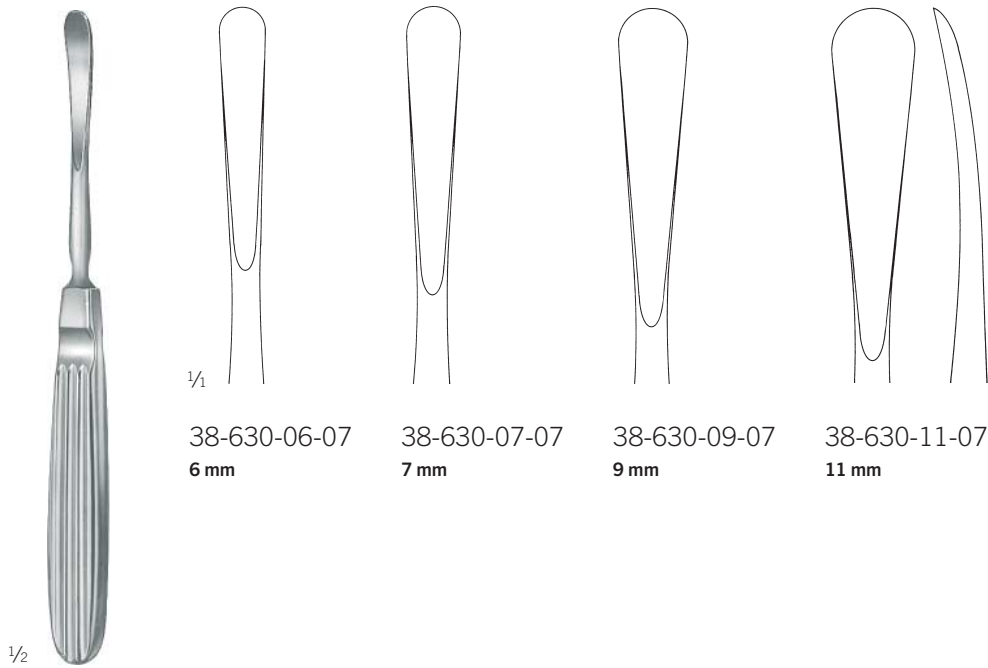

1/4

38-630-06-07
6 mm

38-630-07-07
7 mm

38-630-09-07
9 mm

38-630-11-07
11 mm

1/2

Obwegeser

38-630-06-07 - 38-630-11-07

17,5 cm / 6 7/8"



1/4

38-631-05-07
5 mm

38-631-07-07
7 mm

38-631-09-07
9 mm

1/2

Obwegeser

38-631-05-07 - 38-631-09-07

20 cm / 7 7/8"

Raspatorien

Periosteal Elevators

Periostótomos

Rugines-raspatoires

Periostotomi



1/2



1/1

38-632-01-07



38-632-02-07

Obwegeser

38-632-01-07 - 38-632-02-07

17,5 cm / 6 7/8"



1/2



38-633-01-07

Periostelevatorium
Periosteal Elevator
Legra
Rugine-raspatoire
Elevatore per periosteo



38-633-02-07

Periostelevatorium
Periosteal Elevator
Legra
Rugine-raspatoire
Elevatore per periosteo

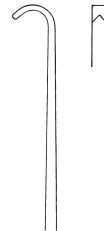

Fig. 11

38-633-03-07

Gelenkpositionierer
Condylar Repositioning Instrument
Instrumento para reposicion condylar
Repositionneur pour articul. mahoire
Strumento di riposizionamento condilare

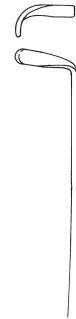
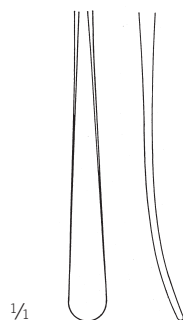
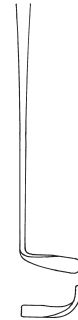
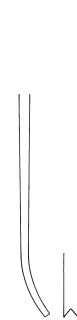

Fig. 12

38-633-04-07



1/1



Krenkel

38-633-01-07 - 38-633-04-07

24,5 cm / 9 5/8"

Elevatoren, Drahtpositionierer, Drahtbogen

Elevators, Wire Pushers
Elevadores, Empujadores de alambres
Elévateurs, Outil de positionnement
Elevatori, Posizionatori per filo

Kraniomaxillofaziale Chirurgie

Craniomaxillofacial surgery
Cirugía cráneo-maxilofacial
Chirurgie crânio-maxillofaciale
Chirurgia cranio-maxillofaciale



Obwegeser
38-640-21-07
20,5 cm / 8 1/8"



Obwegeser
38-642-21-07
20,5 cm / 8 1/8"



38-685-00-07
17 cm / 6 5/8"



Rowe
38-688-15-07
15 cm / 5 7/8"



Erich
38-690-00-07
Gesamtlänge
Overall length
Longitud total
Longueur totale
Lunghezza complessiva
1 m

Elevatoren, Drahtpositionierer, Drahtbogen

Elevators, Wire Pushers

Elevadores, Empujadores de alambres

Elévateurs, Outil de positionnement

Elevatori, Posizionatori per filo

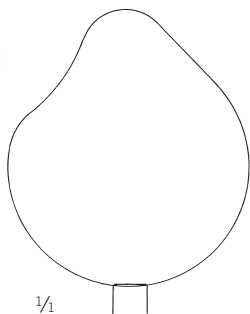

38-691-01-07

rechts
right
derecho
droit
destra

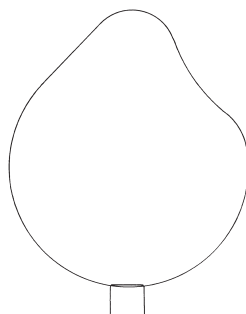

38-691-02-07

links
left
izquierdo
gauche
sinistra

Rowe
38-691-01-07 -
38-691-02-07
19 cm / 7 1/8"

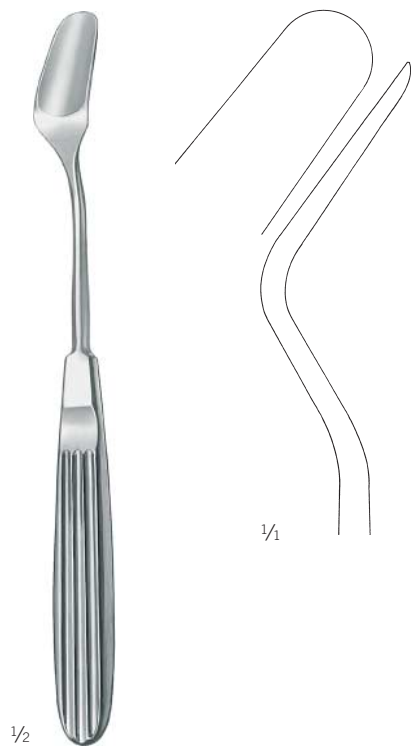

38-693-19-07
20 cm / 7 7/8"

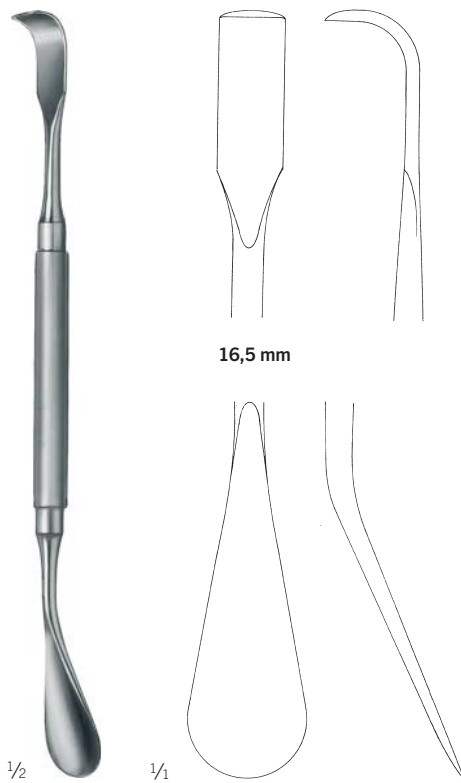

Donovan
38-694-20-07
19,5 cm / 7 5/8"

Orbita-Instrumente

Orbita Instruments
Instrumentos para Orbita
Instruments pour Orbita
Instruments per Orbita

Kraniomaxillofaziale Chirurgie

Craniomaxillofacial surgery
Cirugía cráneo-maxilofacial
Chirurgie crânio-maxillofaciale
Chirurgia cranio-maxillofaciale

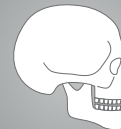

38-695-20-07

20 cm / 7 7/8"

Orbita-Reaktor, links
Orbital retractor, left
Retractor orbital, izquierda
Rétracteur orbital, gauche
Separatore per orbita, sinistra



38-696-20-07

20 cm / 7 7/8"

Orbita-Reaktor, rechts
Orbital retractor, right
Retractor orbital, derecha
Rétracteur orbital, droit
Separatore per orbita, destra



38-697-01-07

20 cm / 7 7/8"

Spatel, orbital, gerade, biegsam,
2 verschiedene Arbeitsenden
Spatula, orbital, straight, malleable,
2 different working ends
Espátula, orbital, recta, maleable,
2 extremos de trabajo diferentes
Spatule, orbitale, droite, malléable,
2 extrémités de travail différentes
Spatola, orbitale, diritta, malleabile,
2 diverse estremità di lavoro

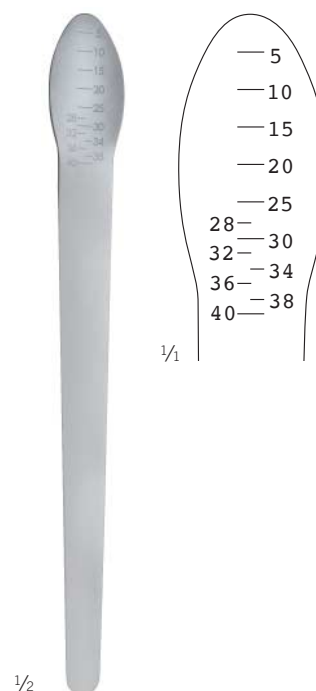

38-697-02-07

18 cm / 7 1/8"

Spatel, orbital, gerade, biegsam
Spatula, orbital, straight, malleable
Espátula, orbital, recta, maleable
Spatule, orbitale, droite, malléable
Spatola, orbitale, diritta, malleabile

Repositionszangen

Disimpaction Forceps

Pinzas para reposición

Pinces de reposition

Pinze per riduzione

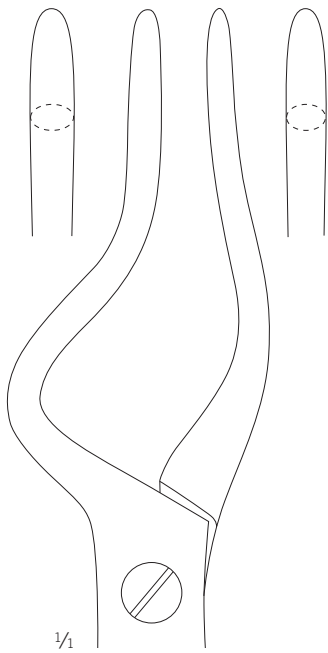

38-700-01-07 **L**
38-701-01-07 **R**
21,5 cm / 8⁴/₈"

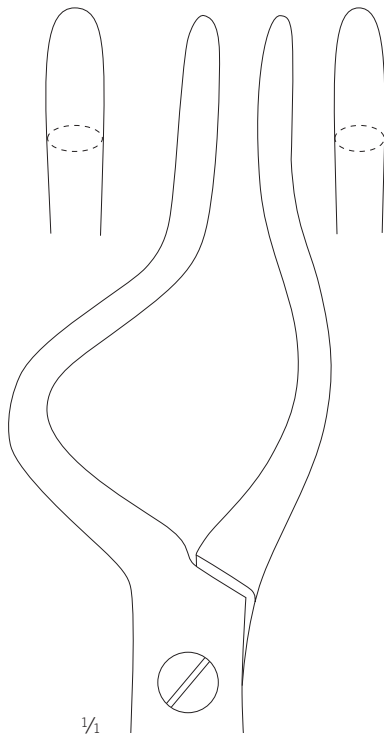

38-700-02-07 **L**
38-701-02-07 **R**
24 cm / 9⁴/₈"

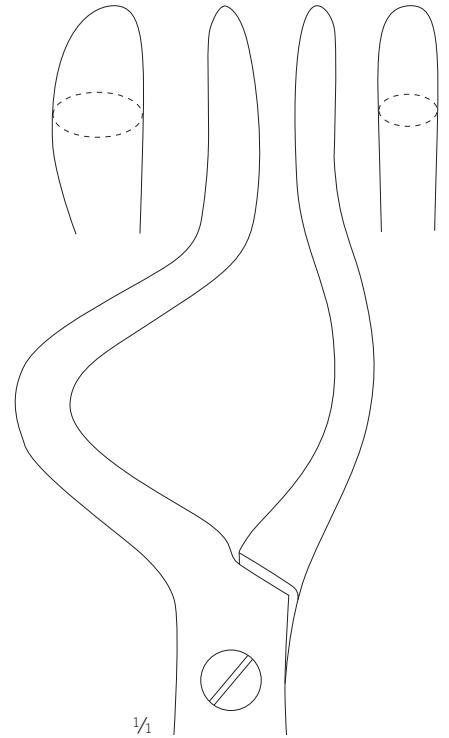

38-700-03-07 **L**
38-701-03-07 **R**
24,5 cm / 9⁵/₈"



Rowe
L
links
left
izquierdo
gauche
sinistra



Rowe
R
rechts
right
derecho
droit
destra

Zygoma-Elevatorien

Zygoma Elevators
Elevadores cigomáticos
Elévateurs zygomatiques
Elevatori per zigomo

Kraniomaxillofaziale Chirurgie

Craniomaxillofacial surgery
Cirugía cráneo-maxilofacial
Chirurgie crânio-maxillofaciale
Chirurgia cranio-maxillofaciale



1/2

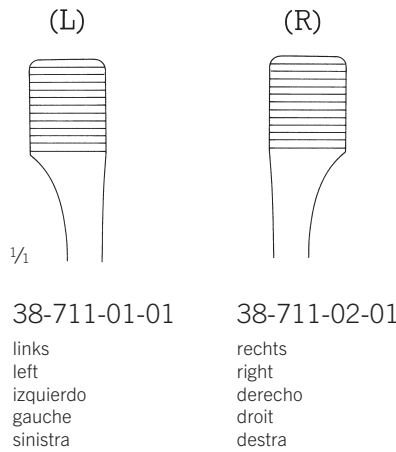

Tessier

38-711-01-01 - 38-711-02-01

Mobilisierhaken
Maxillary Mobilizer
Gancho para movilización
Mobilisateur
Gancio per mobilizzare



1/4

Spitze
tip
punta
pointe
punta
Ø 5,0 mm



1/2

38-711-21-07
25 cm / 9 6/8"



1/2

Dingmann
38-713-21-07
21,5 cm / 8 4/8"

Haken, Knochenhaltezeugen

Hooks, Bone Holding Forceps

Ganchos, Pinzas para huesos

Ecarteurs, Pincers pour os

Divaricatori, Pinze per ossa



Dingmann-Wilk

38-715-19-07

20 cm / 7 7/8"



Eckelt

38-715-21-07

20 cm / 7 7/8"

Plattenzuginstrument

Plate-pulling Instrument

Pinzas agarre para placas

Crochet our maintenir plaque

Strumento per riposizionamento placche



Jeter-Van Sickle

38-718-01-07 -

38-718-02-07

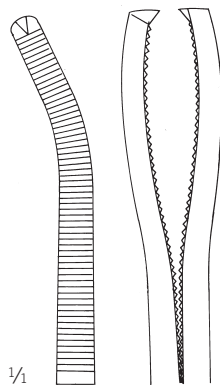

38-718-01-07

19 cm / 7 4/8"

leichtes Modell, für sagittalen Split

light pattern, for sagittal split procedure

modelo ligero, para uso en el sagittal split

modèle léger, pour fente sagittale

modello leggero, per uso dell'osteotomia sagittale



1:2

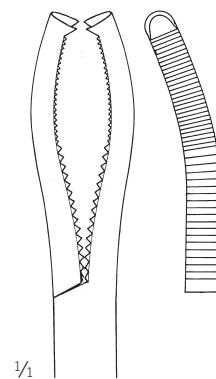

38-718-02-07

18 cm / 7 1/8"

kräftiges Modell, für sagittalen Split

heavy pattern, for sagittal split procedure

modelo fuerte, para uso en el sagittal split

modèle fort, pour fente sagittale

modello pesante, per uso dell'osteotomia sagittale



2:2

Knochenhaltezangen

Bone Holding Forceps

Pinzas para huesos

Pinces pour os

Pinze per ossa

Kraniomaxillofaziale Chirurgie

Craniomaxillofacial surgery

Cirugía cráneo-maxilofacial

Chirurgie crânio-maxillofaciale

Chirurgia cranio-maxillofaciale



1/2

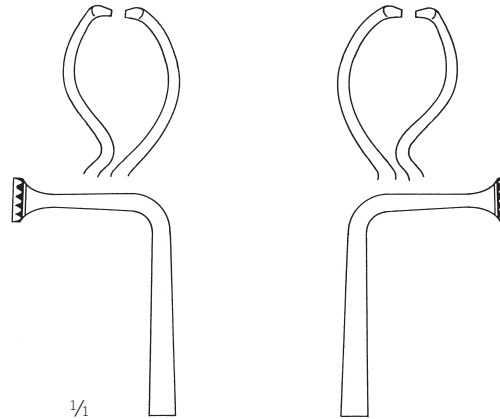

1/1

38-719-01-07

links
left
izquierdo
gauche
sinistra

38-719-02-07

rechts
right
derecho
droit
destra

Keen
38-719-01-07 -
38-719-02-07
17,5 cm / 6 7/8"



1/2

Steinhäuser
38-720-01-07
13,5 cm / 5 3/8"



1/2

Steinhäuser
38-720-02-07
12,5 cm / 4 7/8"

Knochenhaltezangen

Bone Holding Forceps

Pinzas para huesos

Pinces pour os

Pinze per ossa

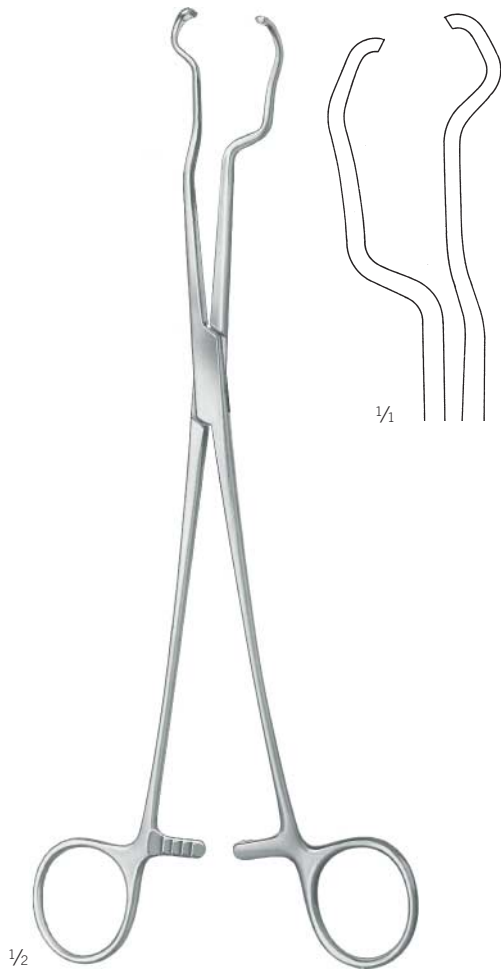

Wolford
38-722-25-07
25 cm / 9 7/8"

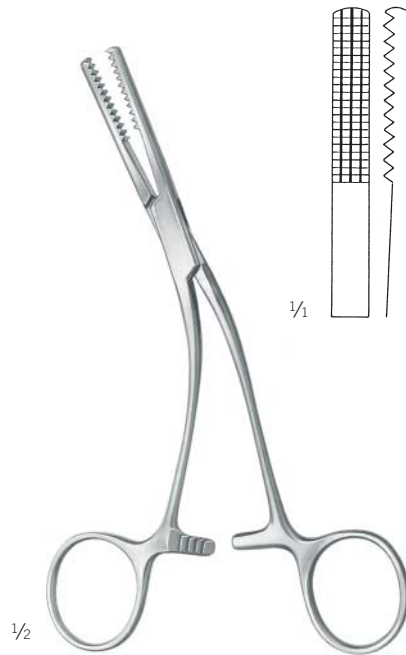

Salyer
38-723-16-07
16,5 cm / 6 4/8"

Instrumente für TMJ

Instruments for TMJ
Instrumentos para TMJ
Instruments pour TMJ
Instruments per TMJ

Kraniomaxillofaziale Chirurgie

Craniomaxillofacial surgery
Cirugía cráneo-maxilofacial
Chirurgie crânio-maxillofaciale
Chirurgia cranio-maxillofaciale



6,5 x 50 mm

1/2

Dunn-Dautrey
38-725-01-07
16 cm / 6 2/8"
Posterior retractor



6,5 x 60 mm

1/2

Dunn-Dautrey
38-725-02-07
16 cm / 6 2/8"
Anterior retractor



8,0 x 50 mm

1/2

Dunn-Dautrey
38-725-03-07
16 cm / 6 2/8"
Superior retractor



6,5 x 50 mm

1/2

Dunn-Dautrey
38-725-04-07
16 cm / 6 2/8"
Superior retractor

Instrumente für TMJ

Instruments for TMJ
Instrumentos para TMJ
Instruments pour TMJ
Instruments per TMJ

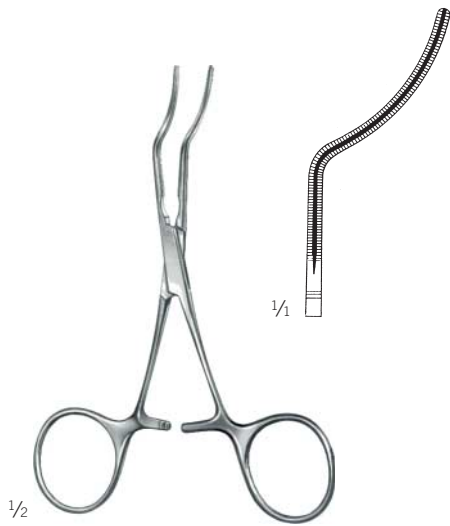

Dolwick
38-731-12-07

12,5 cm / 4 7/8"

TMJ-Disc-Klemme
TMJ Disc Forceps
Pinaz para ATM
Pince mâchoire
Pinza snodo mascella



Dolwick
38-733-13-07

13,5 cm / 5 3/8"

TMJ-Disc-Schere
TMJ Disc Scissors
Tijersa para ATM
Ciseaux mâchoire
Forbice snodo mascella



Dolwick
38-737-17-07

17 cm / 6 6/8"

TMJ-Elevatorium
TMJ-Elevator
Elevador para ATM
Elevateur pour TMJ
Elevatore per TMJ



Dolwick
38-739-14-07

14,5 cm / 5 6/8"

TMJ-Kondylenhaken
TMJ Condyle Hook
Gancho para condilos ATM
Crochet condyle mâchoire
Divaricatore per Condilo

Instrumente für TMJ

Instruments for TMJ
Instrumentos para TMJ
Instruments pour TMJ
Instruments per TMJ

Kraniomaxillofaziale Chirurgie

Craniomaxillofacial surgery
Cirugía cráneo-maxilofacial
Chirurgie crânio-maxillofaciale
Chirurgia cranio-maxillofaciale



1/2

1/1

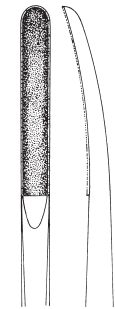

38-741-01-07
15 cm / 5 7/8"

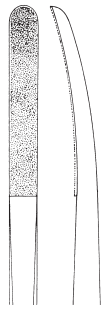

38-741-02-07
15 cm / 5 7/8"

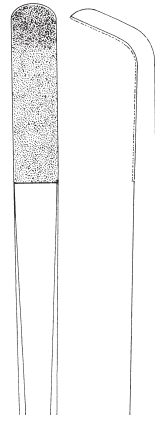

38-741-03-07
17,5 cm / 6 7/8"

Dolwick
38-741-01-07 -
38-741-03-07

TMJ-Raspel
TMJ-Rasp
Escofina para ATM
Râpe pour TMJ
Raspa per TMJ

Instrumente für TMJ

Instruments for TMJ
Instrumentos para TMJ
Instruments pour TMJ
Instruments per TMJ



Dolwick
38-745-01-07
16 cm / 6 $\frac{2}{8}$ "
TMJ-Klemme
TMJ-Forceps
Pinza para ATM
Pinze pour TMJ
Pinza per TMJ



Dolwick
38-745-02-07
16,5 cm / 6 $\frac{4}{8}$ "
TMJ-Klemme
TMJ-Forceps
Pinza para ATM
Pinze pour TMJ
Pinza per TMJ

Instrumente für TMJ

Instruments for TMJ
Instrumentos para TMJ
Instruments pour TMJ
Instruments per TMJ

Kraniomaxillofaziale Chirurgie

Craniomaxillofacial surgery
Cirugía cráneo-maxilofacial
Chirurgie crânio-maxillofaciale
Chirurgia cranio-maxillofaciale



1/2

Champy 38-750-16-07

16 cm / 6 2/8"

TMJ-Spreizer
TMJ-Spreader
Separador para ATM
Ecarteur pour TMJ
Divaricatore per TMJ

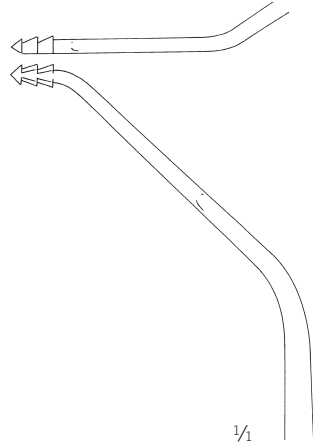

1/1

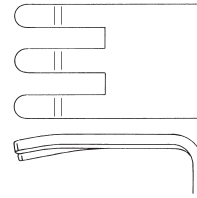

1/2

Wilkes Retractor 38-751-01-07 - 38-751-03-07

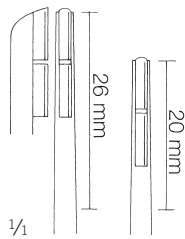

1/1

38-751-01-07

links
left
izquierdo
gauche
sinistra

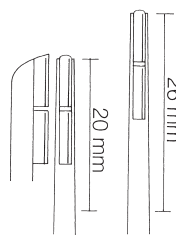

38-751-02-07

rechts
right
derecho
droit
destra

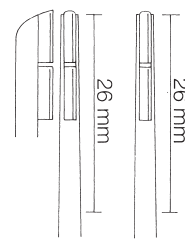

38-751-03-07

gerade
straight
recta
droite
diritta

Osteotome

Osteotomes
 Osteótomos
 Ostéotomes
 Osteotomi

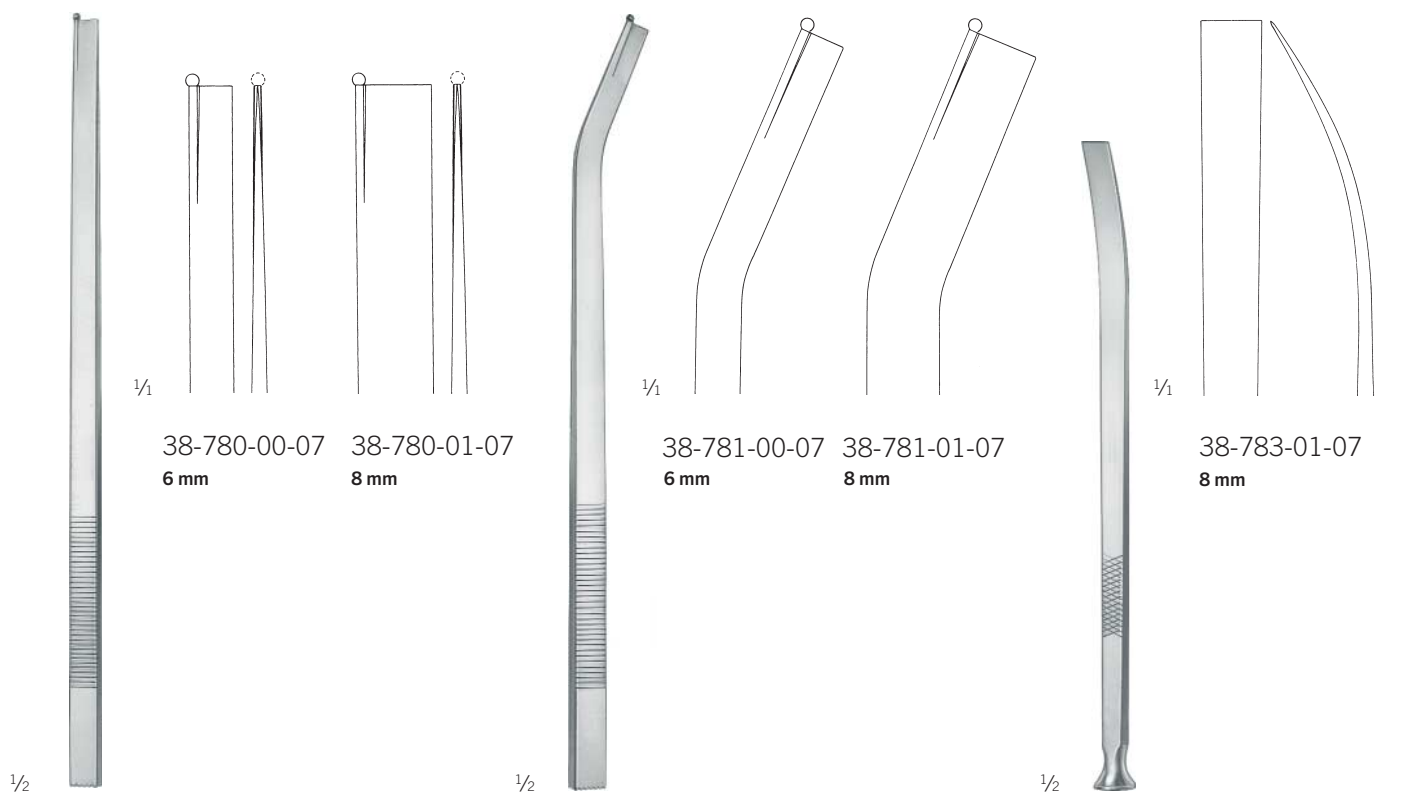

Bauer
 38-780-00-07 -
 38-780-01-07
 20,5 cm / 8 1/8"

Bauer
 38-781-00-07 -
 38-781-01-07
 20,5 cm / 8 1/8"

Epker-Bauer
 38-783-01-07
 17,5 cm / 6 7/8"

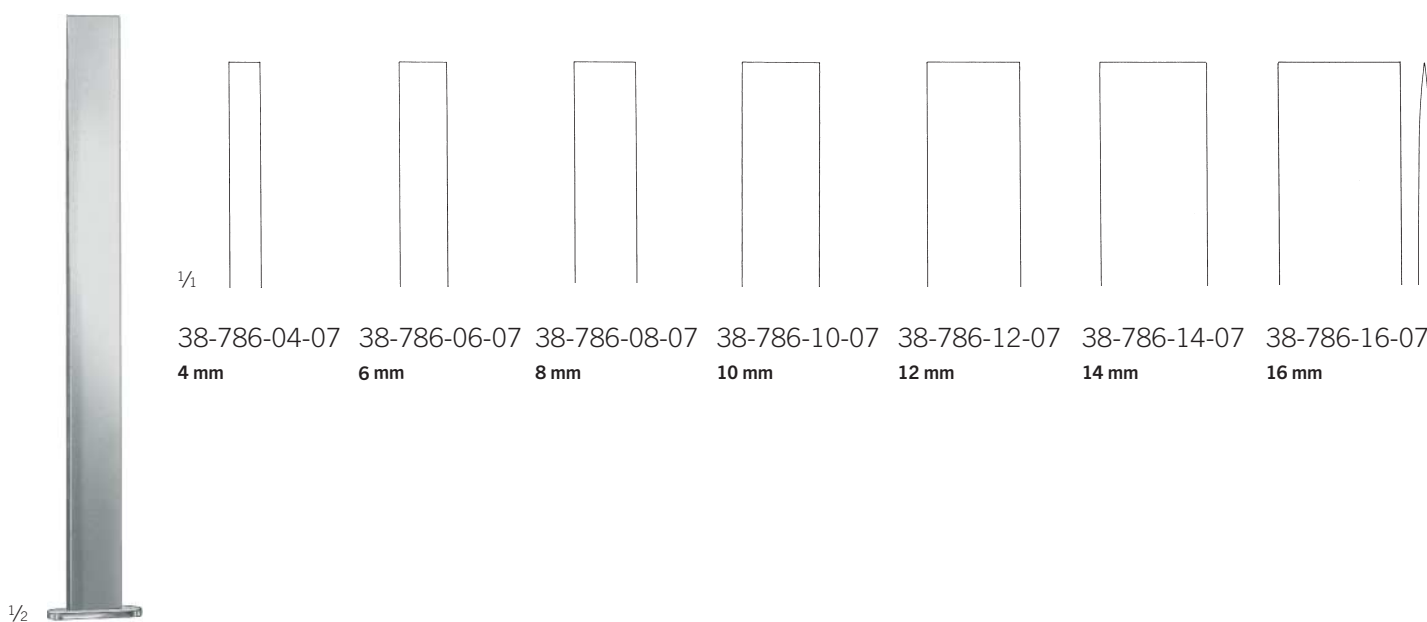

Dautrey-Munro
 38-786-04-07 -
 38-786-16-07
 16 cm / 6 3/8"

Osteotome

Osteotomes
Osteótomos
Ostéotomes
Osteotomi

Kraniomaxillofaziale Chirurgie

Craniomaxillofacial surgery
Cirugía cráneo-maxilofacial
Chirurgie crânio-maxillofaciale
Chirurgia cranio-maxillofaciale



1/4

38-790-04-07
16,5 cm / 6 4/8"
4 mm

38-790-06-07
17 cm / 6 6/8"
6 mm

38-790-08-07
17 cm / 6 6/8"
8 mm

1/2

Dunn-Dautrey
38-790-04-07 -
38-790-08-07



1/4

38-791-01-07
6 mm

38-791-03-07
6 mm

1/2

Dunn-Dautrey
38-791-01-07 -
38-791-03-07
17 cm / 6 6/8"



1/4

8 mm

1/2

Dunn-Dautrey
38-793-03-07
16,5 cm / 6 4/8"

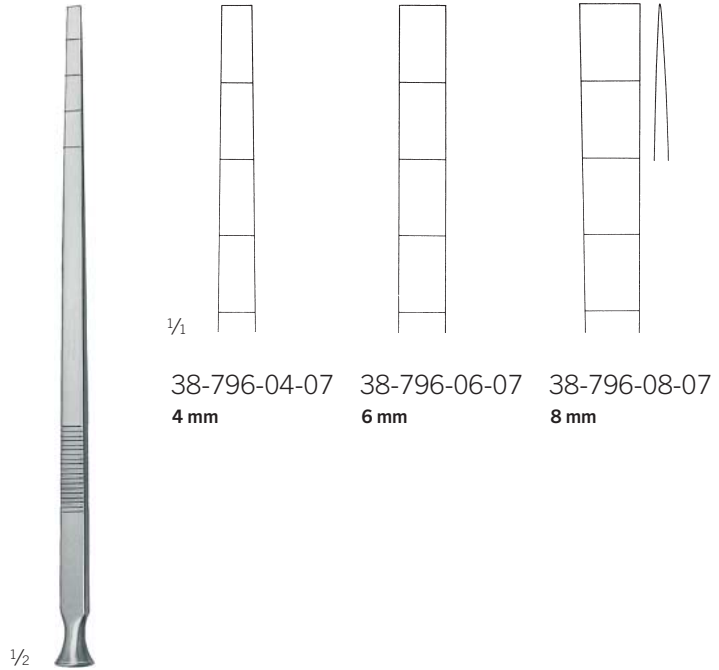

1/4

38-796-04-07
4 mm

38-796-06-07
6 mm

38-796-08-07
8 mm

1/2

Epker
38-796-04-07 -
38-796-08-07
18 cm / 7 1/8"

Osteotome, Meißel

Osteotomes, Chisels

Osteótomos, Cinceles

Ostéotomes, Ciseaux-burins

Osteotomi, Scalpelli

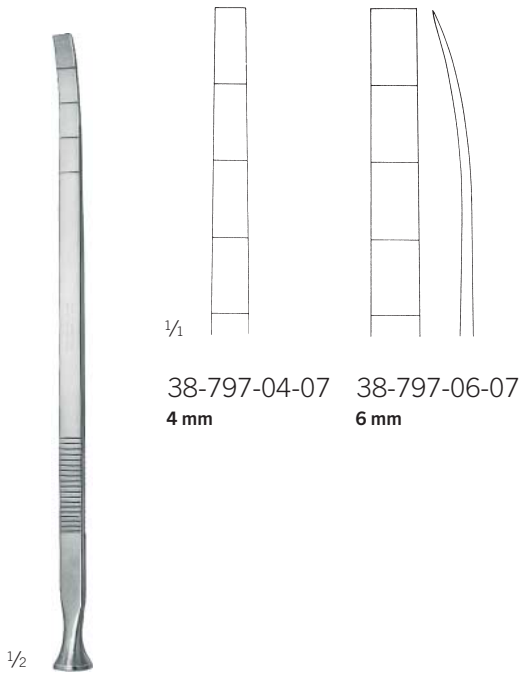

38-797-04-07
4 mm

38-797-06-07
6 mm

Epker
38-797-04-07-
38-797-06-07
18 cm / 7 1/8"

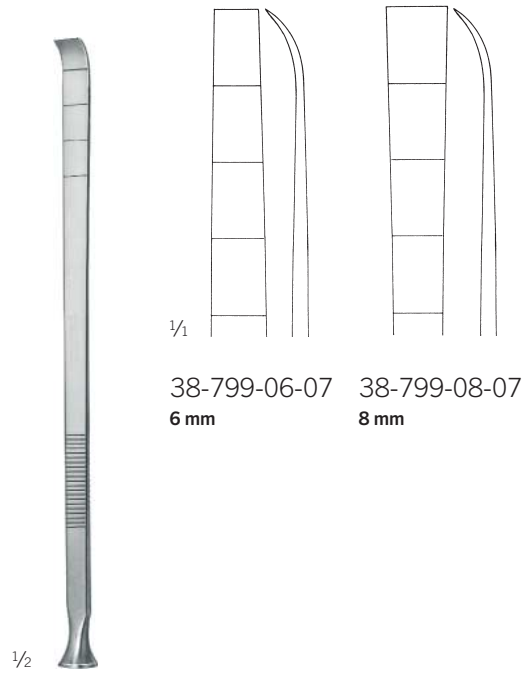

38-799-06-07
6 mm

38-799-08-07
8 mm

Epker
38-799-06-07 -
38-799-08-07
18 cm / 7 1/8"



38-810-00-07
3,7 mm

Urata
38-810-00-07
15 cm, 6"
Spatel
Spatulas
Espátulas
Spátules
Spatole

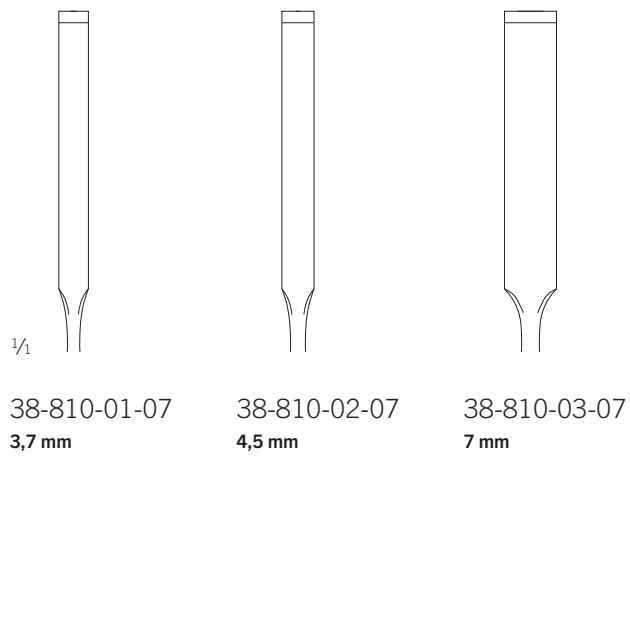

38-810-01-07
3,7 mm

38-810-02-07
4,5 mm

38-810-03-07
7 mm

Martini
38-810-01-07 -
38-810-03-07
15 cm, 6"
Spatel
Spatulas
Espátulas
Spátules
Spatole

Ramushaken

Ramus Retractors
Separadores para el ramo
Ecarteurs pour ramus
Divaricatori per il ramo

Kraniomaxillofaziale Chirurgie

Craniomaxillofacial surgery
Cirugía cráneo-maxilofacial
Chirurgie crânio-maxillofaciale
Chirurgia cranio-maxillofaciale



1/2

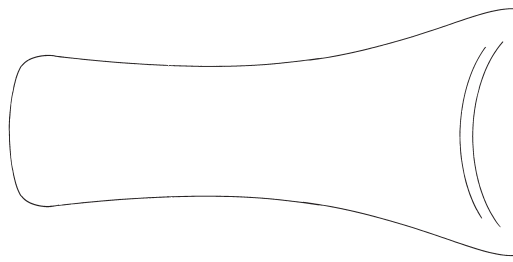
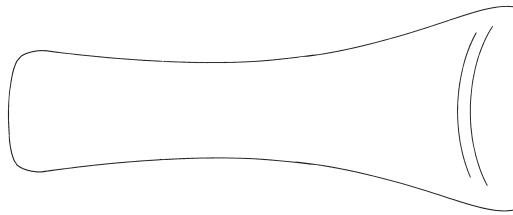

1/4

Hargis 38-829-00-07

16 cm / 6 2/8"

Lippen- und Wangenhalter
Lip and Cheek Retractor
Separador para labios y mejillas
Ecarteur pour lèvres et joues
Separatore per labbra e guancia



1/2

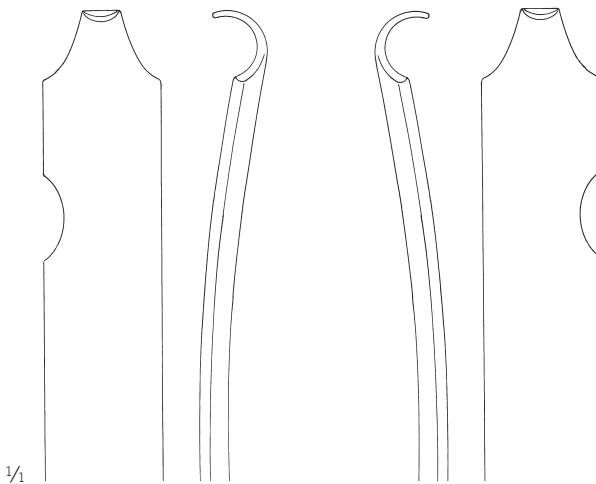

1/4

38-831-01-07

links
left
izquierdo
gauche
sinistra

38-831-02-07

rechts
right
derecho
droit
destra

Hargis 38-831-01-07 - 38-831-02-07

19,5 cm / 7 5/8"

Unterkieferkörperhaken, Vorderrandstripper

Mandibular Body Retractor, Anterior Border Stripper

Separador para el cuerpo mandibular, Separador para el borde anterior

Ecarteur pour corps mandibulaire, Ecarteur pour le bord antérieur

Separatore per il corpo mandibulare, Separatore per il bordo anteriore

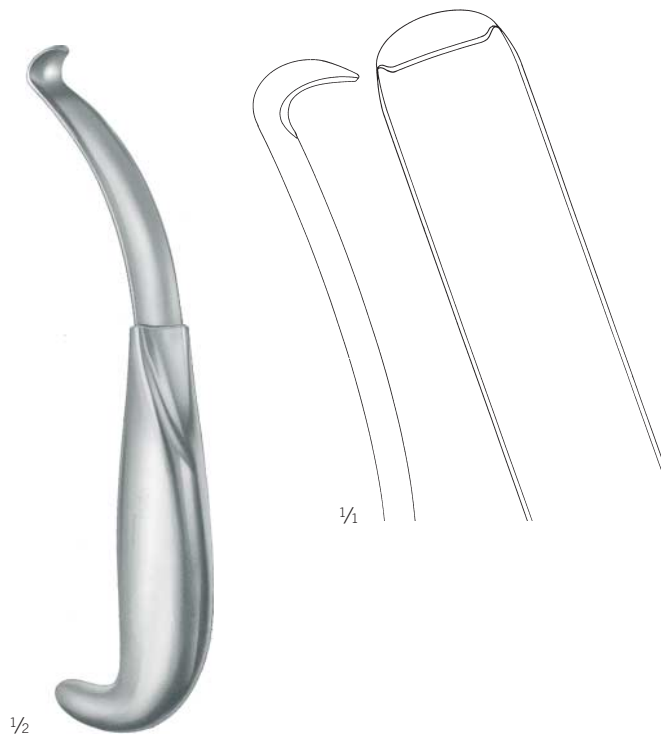

Hargis
38-833-18-07
17,5 cm / 6 7/8"

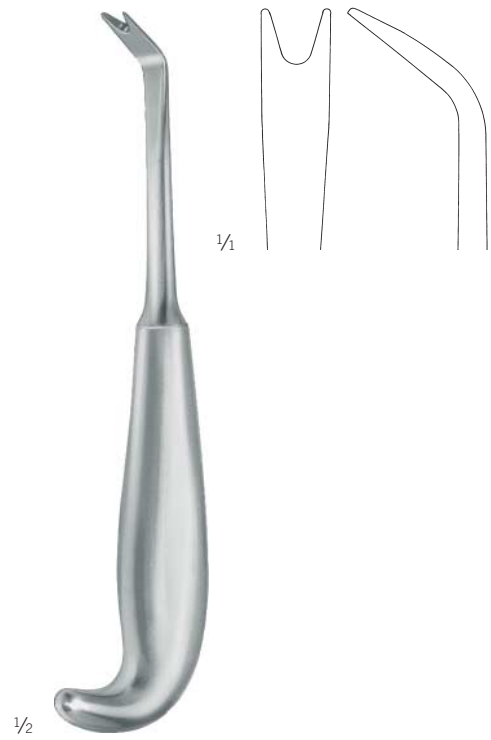

Hargis
38-835-19-07
18,5 cm / 7 2/8"

Raspatorien

Periosteal Elevators
Legras
Rugine-raspatoires
Elevatori per periosteo

Kraniomaxillofaziale Chirurgie

Craniomaxillofacial surgery
Cirugía cráneo-maxilofacial
Chirurgie crânio-maxillofaciale
Chirurgia cranio-maxillofaciale

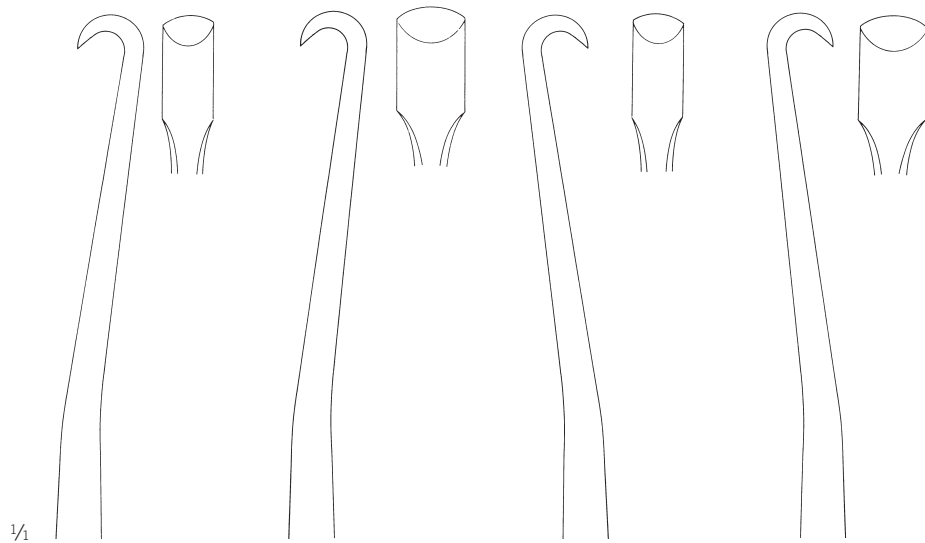

38-837-01-07

23,5 cm / 9 2/8"

6,5 mm

rechts
right
derecho
droit
destra

38-837-02-07

23 cm / 9"

9 mm

rechts
right
derecho
droit
destra

38-837-03-07

23,5 cm / 9 2/8"

6,5 mm

links
left
izquierdo
gauche
sinistra

38-837-04-07

23 cm / 9"

9 mm

links
left
izquierdo
gauche
sinistra

1/2

Hargis
38-837-01-07 -
38-837-04-07

Piriformis-Haken, Pterygoideus-Osteotom, Knochenfassklemme

Periform Rim Retractor, Pterygoid Osteotome, Bone Holding Forceps

Gancho piriforme, Osteótomo pterigoideo, Pinza para coger huesos

Crochet pour la fosse piriforme, Ostéotome ptérygoïde, Pince pour saisir os

Divaricatore per piriforme, Osteotomo per pterigoideo, Afferratoio per ossa

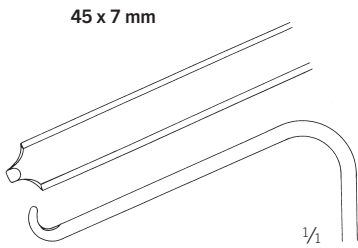

1/2

Hargis
38-839-18-07
18,5 cm / 7 2/8"

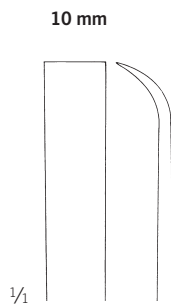

1/2

Hargis
38-841-22-07
22 cm / 8 5/8"



1/2

Hargis
38-843-19-07
19 cm / 7 4/8"
mit Kette
with chain
con catena
avec chaîne
con catena



1/2

38-843-99-07
55 cm / 21 5/8"
Kette, allein
Chain, only
Catena, suelto
Chaîne, seul
Catena, solo

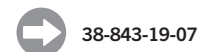

Sagittalspreizer, Spreizzange

Sagittal Split Separators, Ramus Separator
Separadores sagitales, Pinza para separar la rama
Ecarteurs sagitaux, Pince pour séparer ramus
Separatori sagittali, Pinza per separare il ramo

Kraniomaxillofaziale Chirurgie

Craniomaxillofacial surgery
Cirugía cráneo-maxilofacial
Chirurgie crânio-maxillofaciale
Chirurgia cranio-maxillofaciale

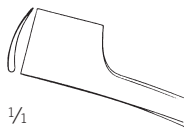

1/1

9 mm

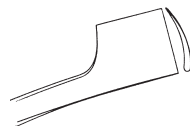

9 mm



1/2



1/2

Smith
38-845-01-07
18,5 cm / 7 2/8"
rechts
right
derecho
droit
destra

Smith
38-845-02-07
18,5 cm / 7 2/8"
links
left
izquierdo
gauche
sinistra



1/2

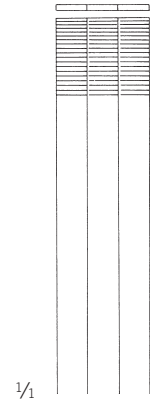

1/1

Smith
38-846-20-07
23,5 cm / 9 2/8"

Mylohyoideusklemmen

Mylohyoid Muscle Clamps

Pinzas para el músculo milohioideo

Clamp mylohyoidal

Pinze per muscolo miloideo

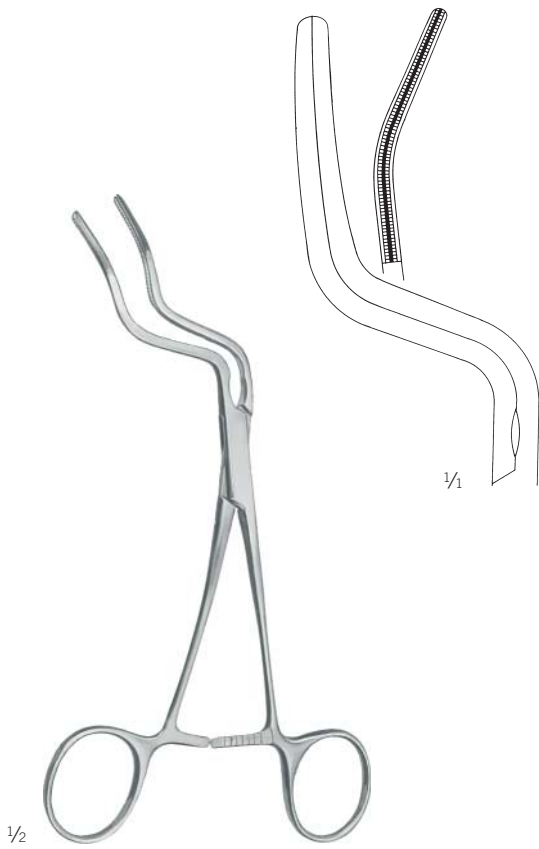

Terry
38-850-01-07

17 cm / 6 ⁵/₈"

links
left
izquierdo
gauche
sinistra

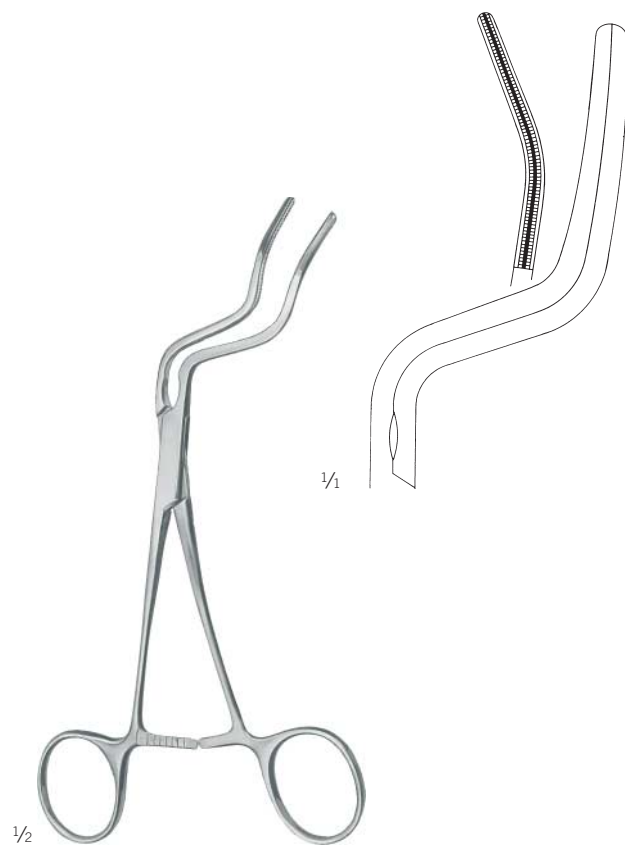

Terry
38-850-02-07

17 cm / 6 ⁵/₈"

rechts
right
derecho
droit
destra

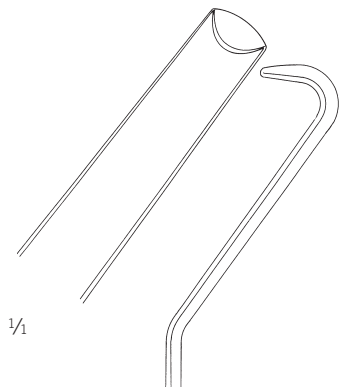

1/1



1/2

Terry
 38-851-16-07

16,5 cm / 6 1/8"

Unterkieferhaken
 Mandibular Retractors
 Gancho mandibular
 Crochet mandibulaire
 Divaricatore per mandibula

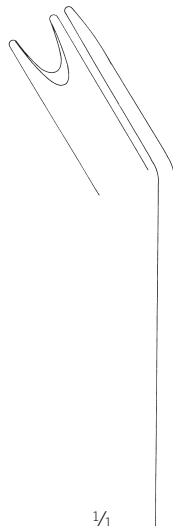

1/1



1/2

Terry
 38-853-24-07

24 cm / 9 1/8"

Ramusschieber
 Ramus Pusher
 Corredera de rama
 Manipulateur pour ramus
 DPosizionatore per ramo

Ø 2,5 mm



1/1



1/2

Terry
 38-855-17-07

17 cm / 6 5/8"

Drahteinführinstrument
 Wire Introducer,
 Introducitor de alambre
 Introducateur pour fil
 Introduttore per filo

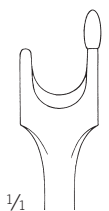

1/1



1/1

Terry
 38-856-19-07

19 cm / 7 1/2"

Septumosteotom
 Septal Osteotome
 Osteótomo nasal
 Ostéotome nasale
 Osteotomo nasale

Haken, Elevatorien

Hooks, Elevators

Ganchos, Elevadores

Ecarteurs, Élévateurs

Divaricatori, Elevatori

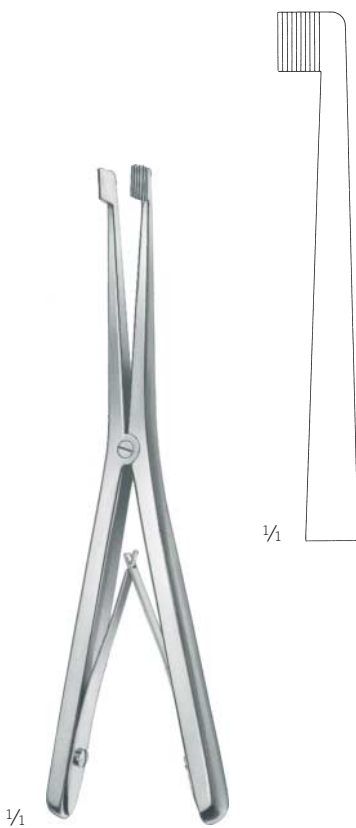

Turvey
38-870-17-07
17 cm / 6 5/8"

Unterkieferhaken
Mandibular Retractors
Gancho mandibular
Crochet mandibulaire
Divaricatore per mandibula

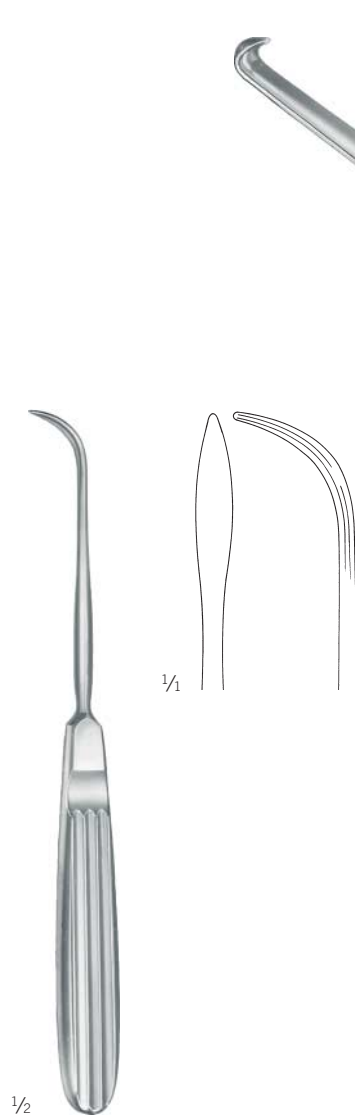

Steinhäuser
38-875-18-07
18,5 cm / 7 2/8"

Unterkieferhaken
Mandibular Retractors
Gancho mandibular
Crochet mandibulaire
Divaricatore per mandibula



Steinhäuser
38-877-00-07
27 cm / 10 5/8"

Elevatorium, extra lang
Elevator, extra long
Elevador de rama, muy largo
Élévateur, très long
Elevatore, molto lungo

Ramusklemmen

Ramus Clamps
Pinzas de rama
Clamps pour ramus
Pinze per ramo

Kraniomaxillofaziale Chirurgie

Craniomaxillofacial surgery
Cirugía cráneo-maxilofacial
Chirurgie crânio-maxillofaciale
Chirurgia cranio-maxillofaciale

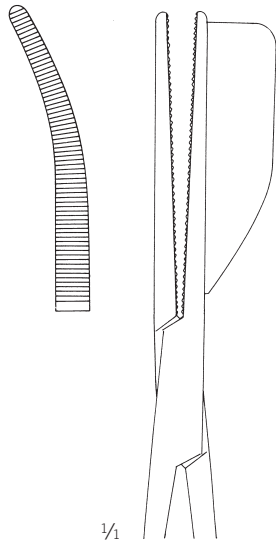

1/1

38-878-01-07

rechts
right
derecho
droit
destra

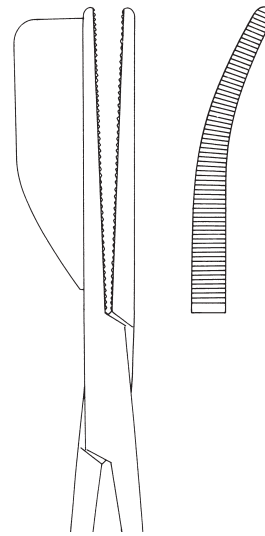

38-878-02-07

links
left
izquierdo
gauche
sinistra



1/2

Steinhäuser
38-878-01-07
16 cm / 6 2/8"



1/2

Steinhäuser
38-878-02-07
16 cm / 6 2/8"

Ramusosteotome, Meißel

Ramus Osteotomes, Chisels

Osteótomos de rama, Cinceles

Ostéotome pour ramus, Ciseaux-burins

Osteotomi per ramo, Scalpelli

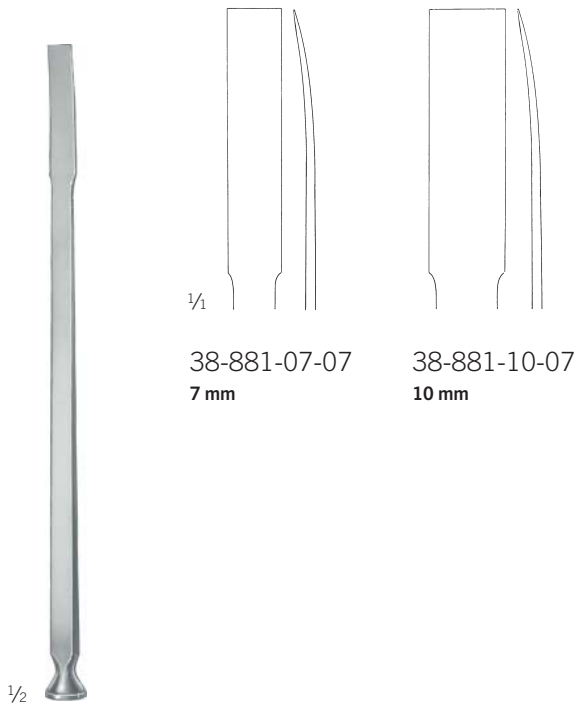

38-881-07-07

7 mm

38-881-10-07

10 mm

Steinhäuser

38-881-07-07 - 38-881-10-07

17 cm / 6 5/8"

flexibel
flexible
flexible
flexible
flessibile

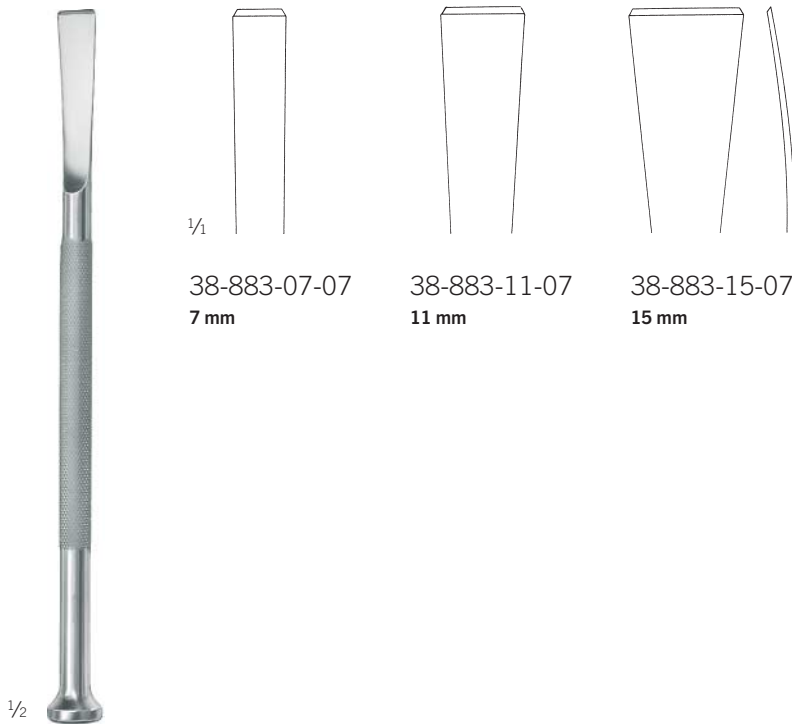

38-883-07-07

7 mm

38-883-11-07

11 mm

38-883-15-07

15 mm

6 mm



1/4

Steinhäuser
38-883-07-07 -
38-883-15-07

19 cm / 7 1/2"

Steinhäuser
38-885-18-07

18 cm / 7 1/8"

Repositionsinstrument
Reposition Instrument
Instrumento de reposición
Pince de réposition
Strumento per riduzione

Zygoma-Wundhaken

Zygomatic Retractor
Separador cigomático
Ecarteur cygomatique
Divaricatore per zigomo

Kraniomaxillofaziale Chirurgie

Craniomaxillofacial surgery
Cirugía cráneo-maxilofacial
Chirurgie crânio-maxillofaciale
Chirurgia cranio-maxillofaciale



1/2

Steinhäuser
38-891-01-07 -
38-891-02-07
25 cm / 9 7/8"

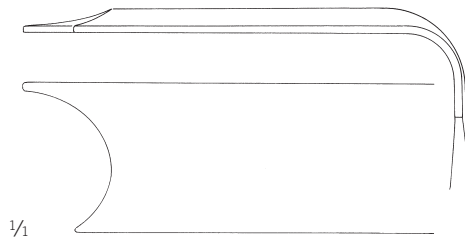

1/1

38-891-01-07

rechts
right
derecho
droit
destra
50 x 20 mm

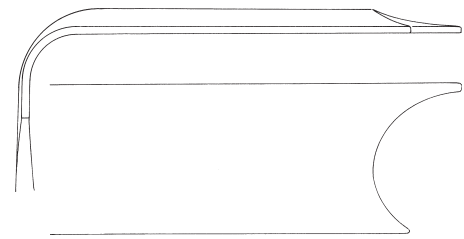

38-891-02-07

links
left
izquierdo
gauche
sinistra
50 x 20 mm

Raspatorien, Osteotome

Raspatories, Osteotomes

Legras, Osteótomos

Rugine-raspatoires, Ostéotomes

Elevatori per periosteo, Osteotomi

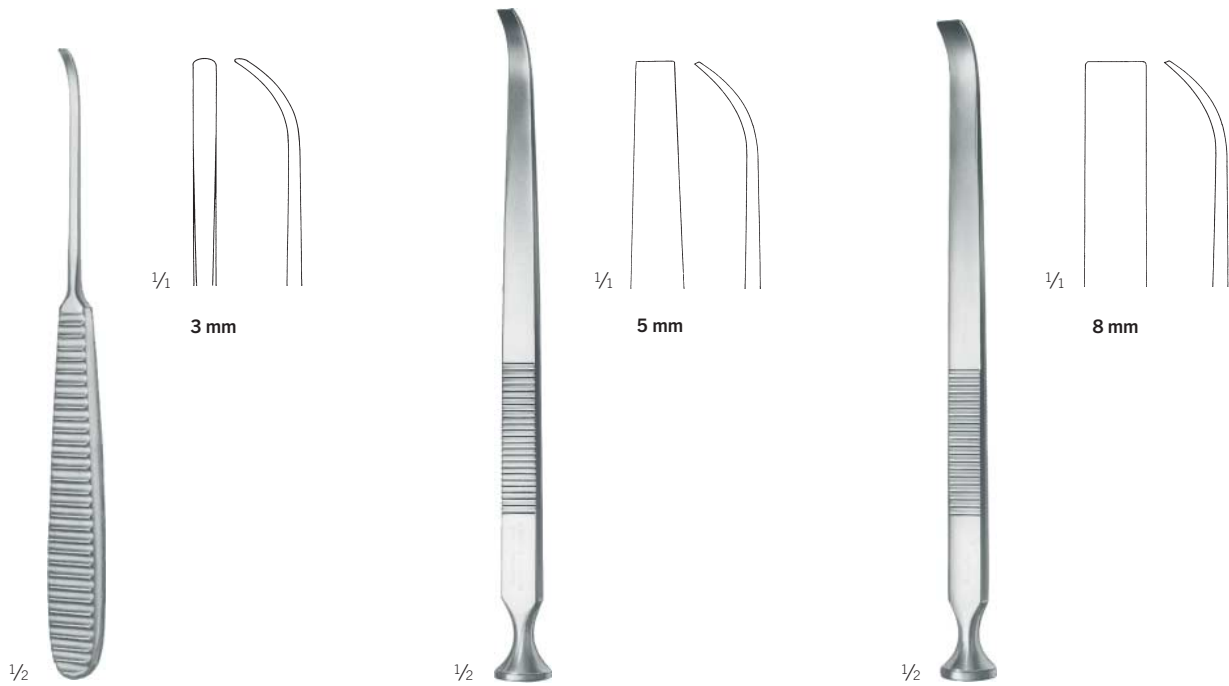

Steinhäuser
38-893-16-07
16,5 cm / 6 ⁴/₈"

Steinhäuser
38-895-05-07
18 cm / 7 ¹/₈"

Steinhäuser
38-895-08-07
18 cm / 7 ¹/₈"



38-899-06-07
6 mm

38-899-08-07
8 mm

Wolford
38-899-06-07 -
38-899-08-07
21,5 cm / 8 ⁴/₈"

Weichteilhaken

Soft Tissue Retractors
Separadores para partes blandas
Ecarteurs pour parties molles
Divaricatori per tessuti molli

Kraniomaxillofaziale Chirurgie

Craniomaxillofacial surgery
Cirugía cráneo-maxilofacial
Chirurgie crânio-maxillofaciale
Chirurgia cranio-maxillofaciale

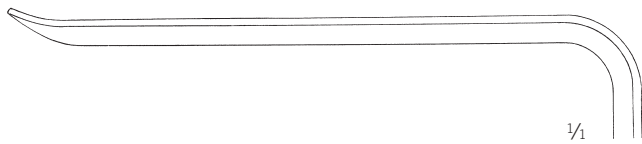

1/2

Obwegeser
48-101-16-07 -
48-101-80-07
aufwärts gebogen
bent upwards
angulado hacia arriba
coudé en haut
angolato in alto

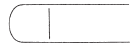

48-101-16-07

21,5 cm / 8 4/8"

16 x 5 mm

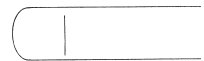

48-101-25-07

21 cm / 8 2/8"

25 x 7 mm

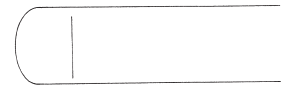

48-101-35-07

23 cm / 8"

35 x 10 mm

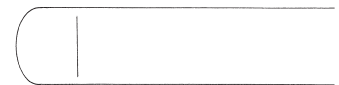

48-101-42-07

23 cm / 8"

42 x 10 mm

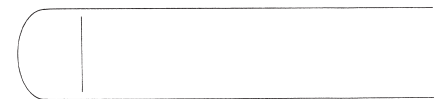

48-101-55-07

23,5 cm / 9 2/8"

57 x 12,5 mm

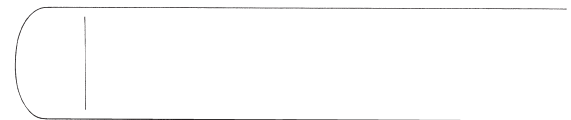

48-101-70-07

23,8 cm / 9 3/8"

72 x 15 mm

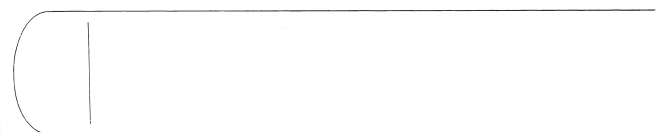

1/1

48-101-80-07

24 cm / 9 4/8"

86 x 17 mm

Weichteilhaken

Soft Tissue Retractors

Separadores para partes blandas

Ecarteurs pour parties molles

Divaricatori per tessuti molli

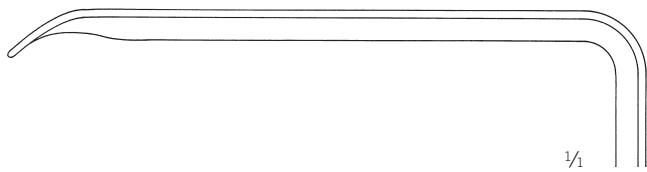

1/2

Obwegeser
48-103-16-07 -
48-103-80-07

abwärts gebogen
bent downwards
angulado hacia abajo
coudé en bas
angolato in basso

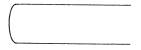

48-103-16-07

21 cm / 8 2/8"

16 x 5 mm



48-103-25-07

21 cm / 8 2/8"

25 x 7 mm

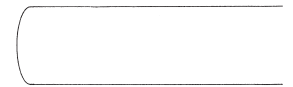

48-103-35-07

23 cm / 8"

35 x 10 mm

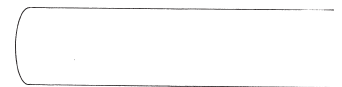

48-103-42-07

23 cm / 8"

42 x 10 mm

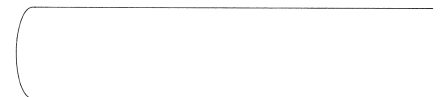

48-103-55-07

23,5 cm / 9 2/8"

55 x 12 mm

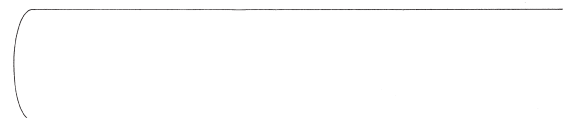

48-103-70-07

23,5 cm / 9 2/8"

72 x 15 mm

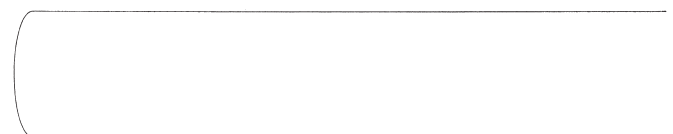

1/4

48-103-80-07

23,5 cm / 9 2/8"

86 x 17 mm

Haken

Retractors
Separadores
Ecarteurs
Divaricatori

Kraniomaxillofaziale Chirurgie

Craniomaxillofacial surgery
Cirugía cráneo-maxilofacial
Chirurgie crânio-maxillofaciale
Chirurgia cranio-maxillofaciale

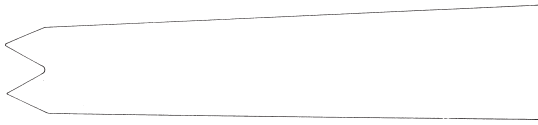

48-107-22-07
75 x 11/15 mm

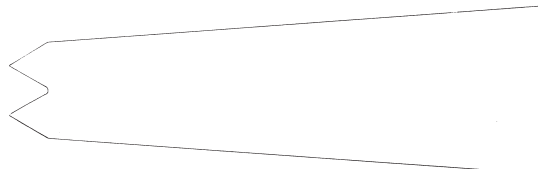

$\frac{1}{1}$
48-109-22-07
75 x 12/22 mm

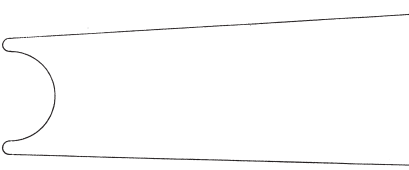
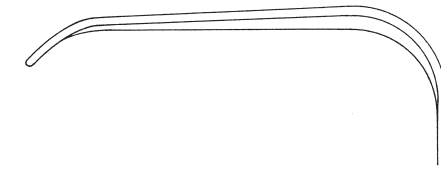

$\frac{1}{1}$
75 x 12/22 mm

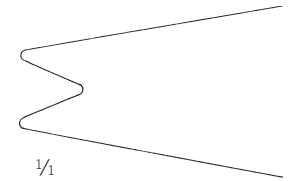

$\frac{1}{1}$
45 x 10/23 mm



$\frac{1}{1}$



$\frac{1}{2}$

Obwegeser
48-111-22-07
24 cm / 9 $\frac{4}{8}$ "
Weisheitszahn-Haken
Third Molar Retractor
Separador para muela del juicio
Ecarteur pour dent de sagesse
Separatore per il dente del giudizio



$\frac{1}{2}$

Obwegeser
48-113-22-07
24 cm / 9 $\frac{4}{8}$ "
Spina nasalis-Haken
Nasal Spine Retractor
Separador para espina nasal
Ecarteur pour spina nasalis
Separatore per spina nasale

$\frac{1}{2}$

Obwegeser
48-107-22-07 - 48-109-22-07
24 cm / 9 $\frac{4}{8}$ "
Ramushaken
Ramus Retractors
Separadores para el ramo
Ecarteurs pour ramus
Divaricatori per il ramo

Ramusklappen, Progenierinnen

Ramus Clamps, Channel Retractors

Pinzas para el ramo, Separadores mandibulares

Pinces pour ramus, Ecarteurs mandibulaires

Pinze per il ramo, Divaricatori mandibulari



1/2

Obwegeser
48-115-01-07

16,5 cm / 6 4/8"

kleines Modell, rechts
small pattern, right
modelo pequeño, derecho
modèle petit, droite
modello piccolo, destro



1/2

Obwegeser
48-115-02-07

16,5 cm / 6 4/8"

kleines Modell, links
small pattern, left
modelo pequeño, izquierdo
modèle petit, gauche
modello piccolo, sinistra

Obwegeser
48-117-01-07

17 cm / 6 6/8"

großes Modell, rechts
large pattern, right
modelo grande, derecho
modèle grand, droite
modello grande, destro

Obwegeser
48-117-02-07

17 cm / 6 6/8"

großes Modell, links
large pattern, left
modelo grande, izquierdo
modèle grand, gauche
modello grande, sinistra



1/2

Obwegeser
48-121-08-07 -
48-121-10-07

1/1

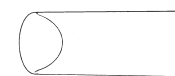

48-121-08-07

16 cm / 6 2/8"

9 mm

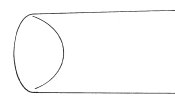

48-121-10-07

16,5 cm / 6 4/8"

10 mm



1/2

Obwegeser
48-125-15-07

16 cm / 6 2/8"

Kinnhalter
Chin Holder
Separador para mentón
Ecarteurs pour menton
Separatore per mento

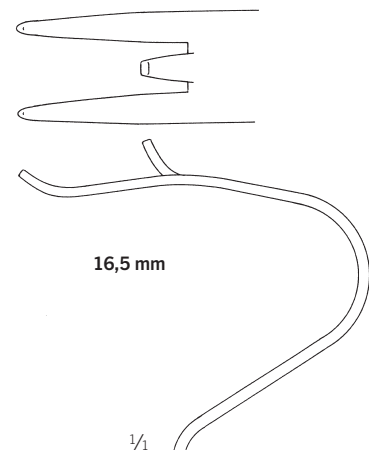

16,5 mm

1/1

Raspatorien

Periosteal Elevators
Periostótomos
Rugines-raspatoires
Periostotomi

Kraniomaxillofaziale Chirurgie

Craniomaxillofacial surgery
Cirugía cráneo-maxilofacial
Chirurgie crânio-maxillofaciale
Chirurgia cranio-maxillofaciale

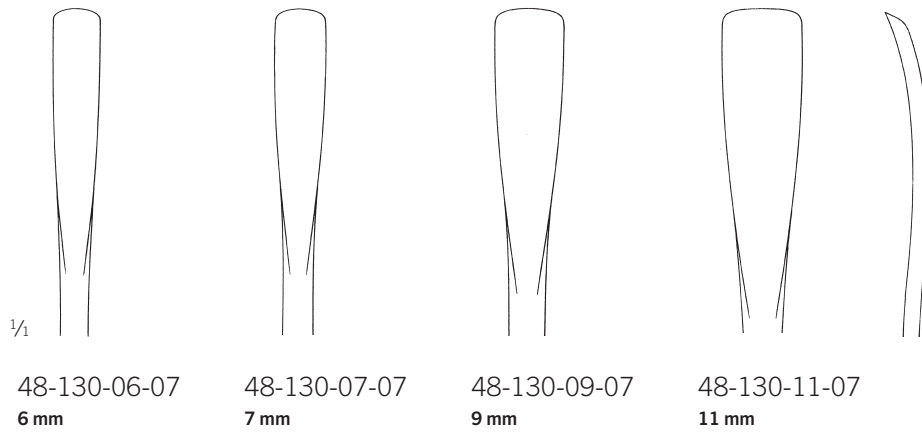

Obwegeser

48-130-06-07 - 48-130-11-07

18 cm / 7 1/8"

winkelig angeschliffen
angled cutting
biselado angular
tranchant angulé
affilatura angolata

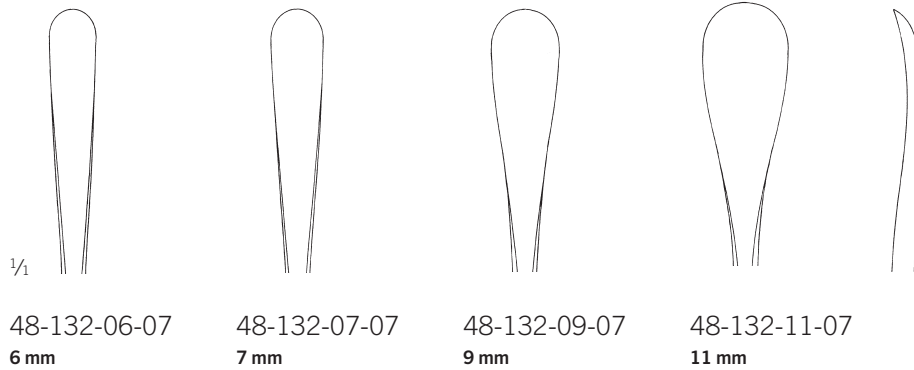

Obwegeser

48-132-06-07 - 48-132-11-07

18 cm / 7 1/8"

flach angeschliffen
flat cutting
biselado plano
tranchant plat
affilatura plana

Unterkieferrand-Raspatorien, Schwabenschwanz-Raspatorien

Mandibular Inferior Border Raspatories, Swallowtail Raspatories

Legras para el borde mandibular, Legras en forma de cola de milano

Rugine-raspatoires pour le bord mandibulaire, Rugine-raspatoires sous forme de queue d'aronde

Staccaperiostio per bordo mandibulare, Staccaperiostio a coda di rondine



Obwegeser
48-135-21-07
21 cm / 8 2/8"



Obwegeser
48-137-21-07
21 cm / 8 2/8"



Obwegeser
48-140-01-07
18 cm / 7 1/8"
nach links gewinkelt
angled to left
angulado hacia la izquierda
coudé à gauche
angolato a sinistra

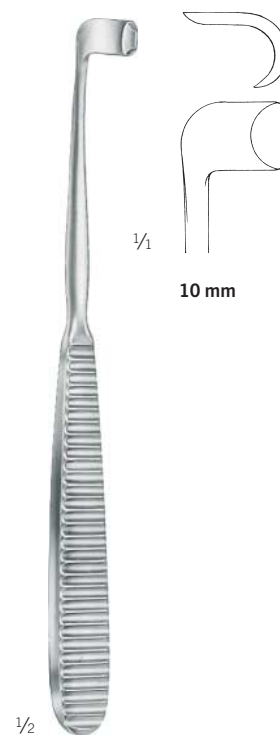

Obwegeser
48-140-02-07
18 cm / 7 1/8"
nach rechts gewinkelt
angled to right
angulado hacia la derecha
coudé à droite
angolato a destra

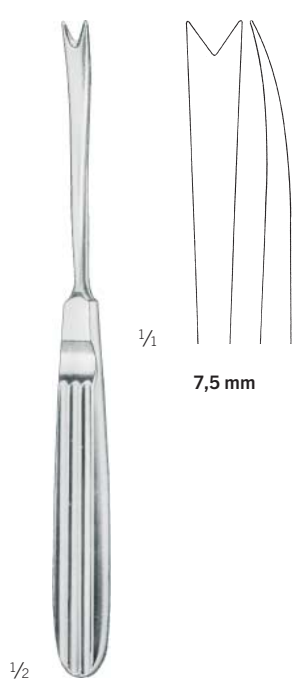

Obwegeser
48-150-01-07
17,5 cm / 6 7/8"

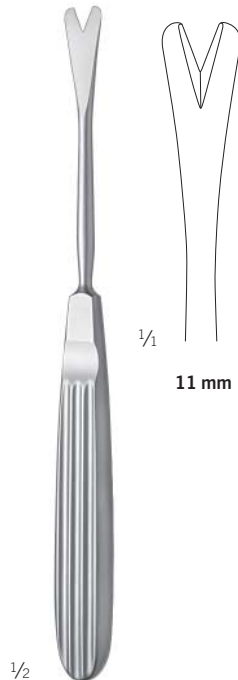

Obwegeser
48-150-02-07
17,5 cm / 6 7/8"

Ramusraspatorien, Septumosteotome

Ramus Periosteal Elevators, Septonasal Osteotomes

Legras para el ramo, Osteótomos para el tabique nasal

Rugine-raspatoires pour ramus, Ostéotomes pour cloison nasale

Elevatori periostali per ramo, Osteotomo per setto nasale

Kraniomaxillofaziale Chirurgie

Craniomaxillofacial surgery

Cirugía cráneo-maxilofacial

Chirurgie crânio-maxillofaciale

Chirurgia cranio-maxillofaciale



1/4

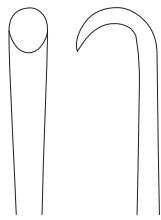

48-152-05-07
5 mm

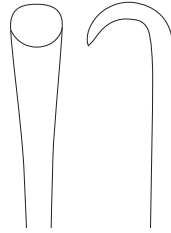

48-152-07-07
7 mm

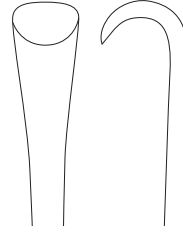

48-152-09-07
9 mm

1/2

Obwegeser

48-152-05-07 - 48-152-09-07

21 cm / 8 1/8"



1/4

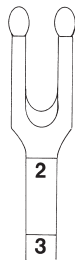

48-156-04-07
4 mm

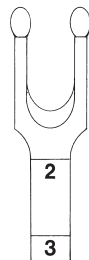

48-156-06-07
6 mm

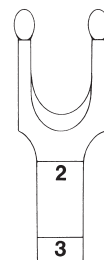

48-156-08-07
8 mm

1/2

Obwegeser

48-156-04-07 - 48-156-08-07

19 cm / 7 1/8"

graduiert
graduated
graduado
gradué
graduato

Keilosteotome, Blattosteotome

Wedge Osteotomes, Blade Osteotomes

Osteótomos de cuña, Osteótomos de hoja

Ostéotome cunéiforme, Ostéotome en lame

Osteotomo a forma di cuneo, Osteotomo

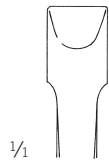

48-160-08-04
8 mm



48-160-12-04
12 mm

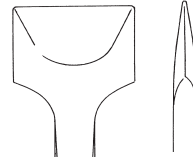

48-160-16-04
16 mm

Obwegeser
48-160-08-04 -
48-160-16-04
22,5 cm / 8 7/8"

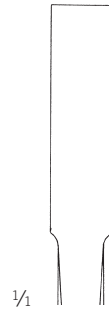

48-162-08-04
8 mm



48-162-12-04
12 mm

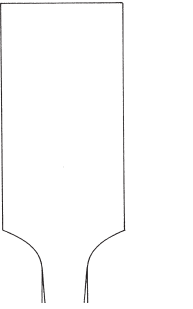

48-162-16-04
16 mm

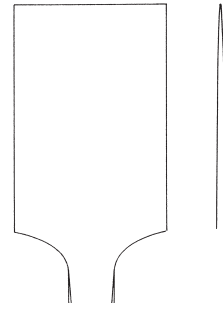

48-162-20-04
20 mm

Obwegeser
48-162-08-04 -
48-162-20-04
22,5 cm / 8 7/8"



Fragment-Adaptierungsklemmen

Fragment Adapting Forceps

Pinzas adaptadoras para fragmentos

Clamps pour adaptation de fragments osseux

Pinze per avvicinare frammenti

Kraniomaxillofaziale Chirurgie

Craniomaxillofacial surgery

Cirugía cráneo-maxilofacial

Chirurgie crânio-maxillofaciale

Chirurgia cranio-maxillofaciale



Atrauma

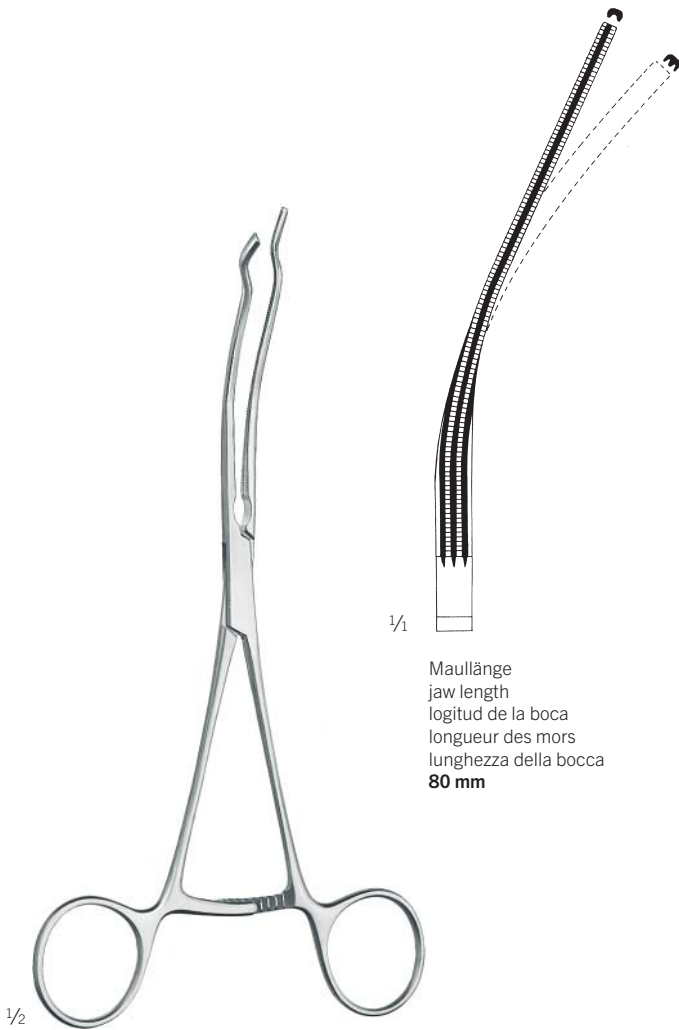

Mauillänge
jaw length
logitud de la boca
longueur des mors
lunghezza della bocca
80 mm

Obwegeser
48-163-01-07

21 cm / 8 2/8"

links
left
izquierdo
gauche
sinistra

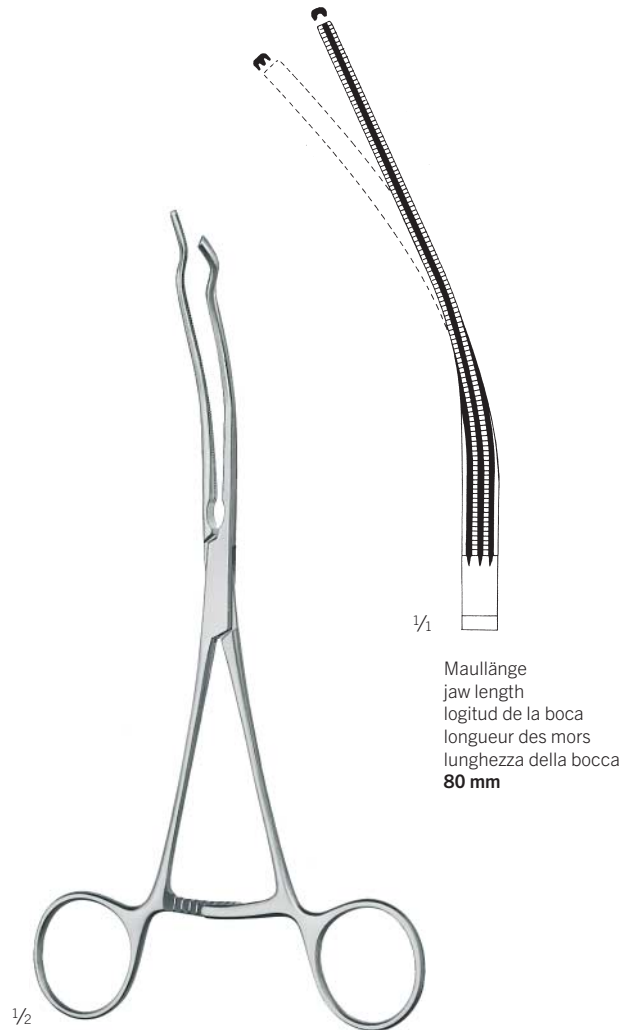

Mauillänge
jaw length
logitud de la boca
longueur des mors
lunghezza della bocca
80 mm

Obwegeser
48-163-02-07

21 cm / 8 2/8"

rechts
right
derecho
droit
destra

Knochenspreizer

Bone-spreader

Separador de huesos

Pince à écarter

Pinza per allargare

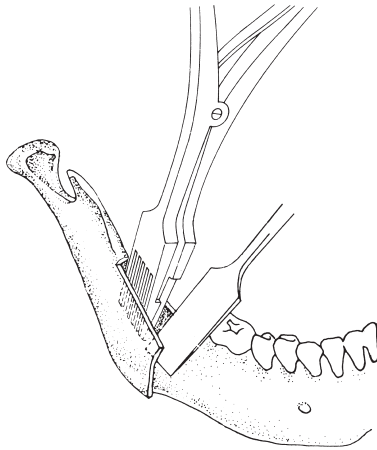

These bone separators serve to open osteotomies, e.g. in sagittal splitting of the lower jaw, in movement of cranial vault segments and in LeFort III osteotomies.



1/2

Obwegeser
48-164-15-07 -
48-164-20-07
22 cm / 8 5/8"

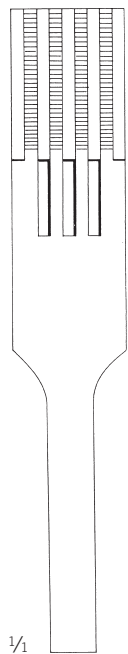

48-164-15-07
15 mm

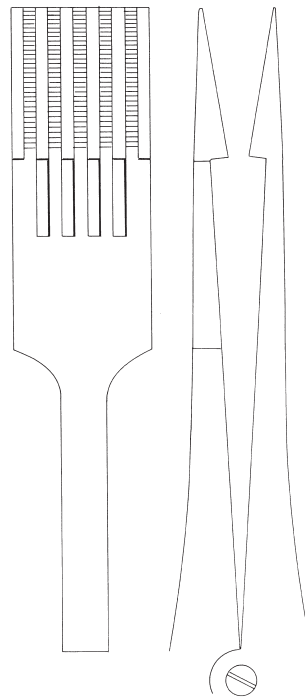

48-164-20-07
20 mm

Tuber maxillae-Osteotome, Osteotome, Alveolarfortsatz-Osteotome

Osteotomes for Maxillary Tuber, Osteotomes, Osteotomes for Alveolar Process
 Osteótomos para tubérculo maxilar, Osteótomos, Osteótomos para el proceso alveolar
 Ostéotome pour tuber-maxillae, Ostéotomes, Ostéotome pour bord alvéolaire
 Osteotomo per tuberosità mascellari, Osteotomo, Osteotomo per processo alveolare

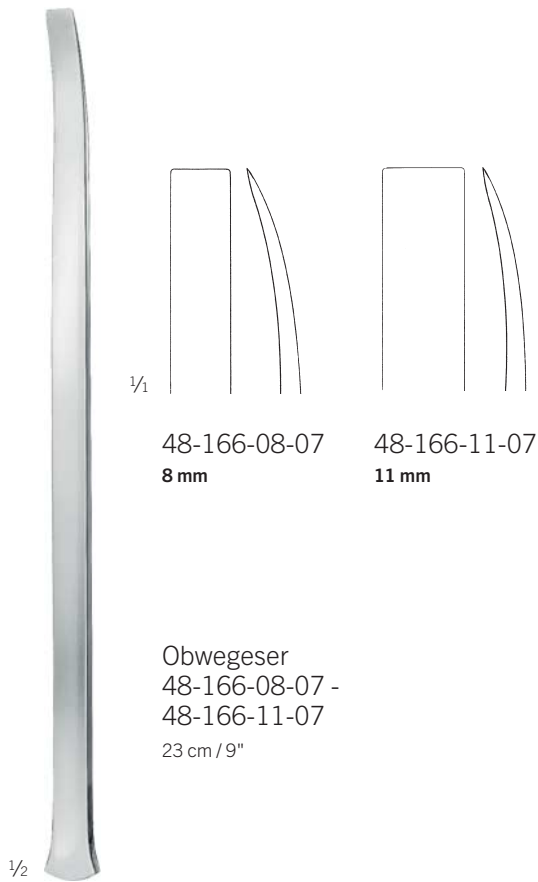
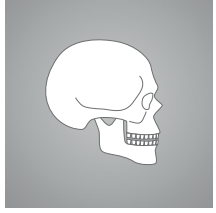

1/2

48-166-08-07
8 mm

48-166-11-07
11 mm

Obwegeser
48-166-08-07 -
48-166-11-07
23 cm / 9"

1/2



1/2

48-167-08-07
8 mm

48-167-11-07
11 mm

Obwegeser
48-167-08-07 -
48-167-11-07
21 cm / 8 2/8"
elastische Klinge
elastic blade
hoja elástica
lame élastique
lama elastica

1/2

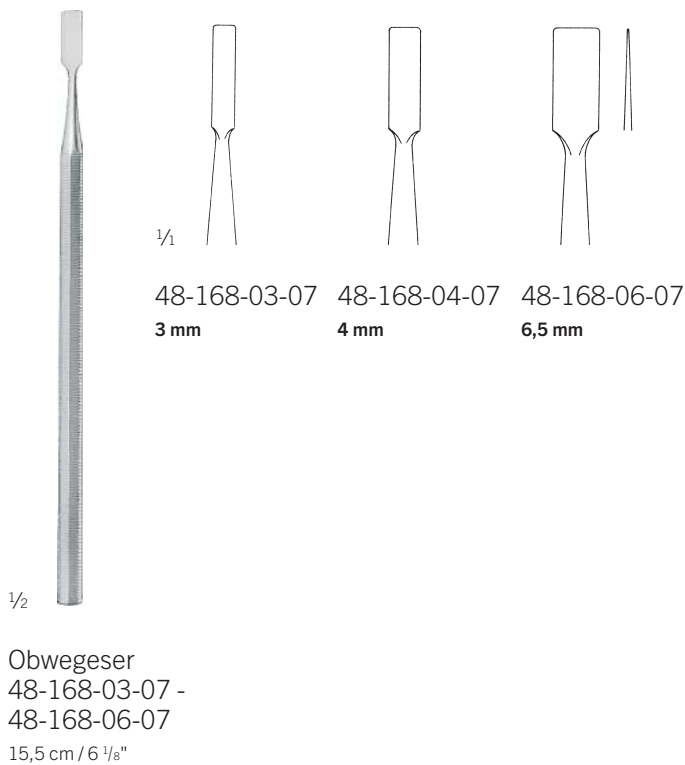

1/2

48-168-03-07
3 mm

48-168-04-07
4 mm

48-168-06-07
6,5 mm

1/2

Obwegeser
48-168-03-07 -
48-168-06-07
15,5 cm / 6 1/8"

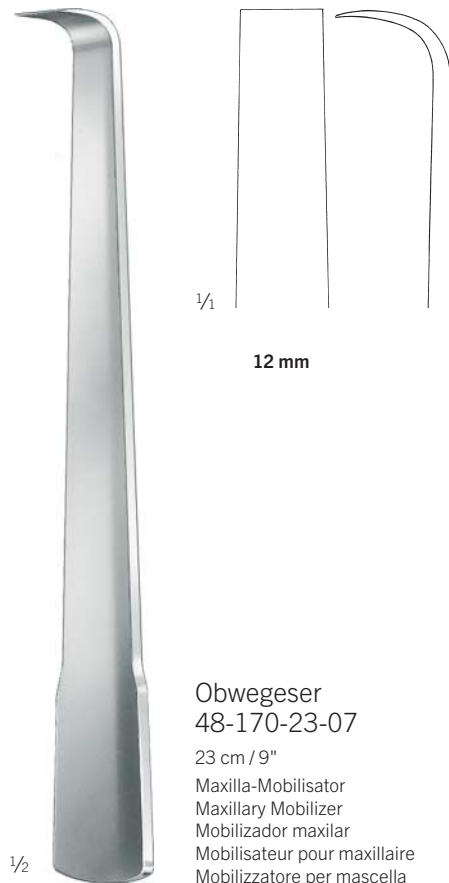

1/2

12 mm

1/2

Obwegeser
48-170-23-07
23 cm / 9"
Maxilla-Mobilisator
Maxillary Mobilizer
Mobilizador maxilar
Mobilisateur pour maxillaire
Mobilizzatore per mascella

Unterkieferahlen, Jochbogenahle

Maxillary Awls, Zygomatic Arch Awl

Leznas maxilares, Lezna para el arco cigomático

Alènes maxillaires, Alène pour l'arcade zygomatique

Punteruolo per mandibola, Punteruolo per arco zigomatico



Obwegeser
48-175-15-07
15 cm / 5 7/8"



Obwegeser
48-175-17-07
17,5 cm / 6 7/8"



Obwegeser
48-177-24-07
24 cm / 9 4/8"

Drahtschneidezange, Flachzangen, Drahtwirbelzangen

Wire Cutter, Flat Nose Pliers, Wire Twisting Forceps

Alicates para alambre, Alicates de pico plano, Pinzas para torcer alambre

Pinces à couper le fil, Pinces plate, Pinces à torsader le fil

Tronchesino, Tenaglie piatta, Pinze per ritorcere fili

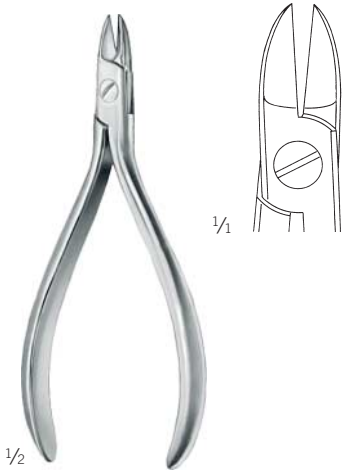

1/2

Obwegeser
48-190-11-07
12 cm / 4 5/8"



1/2

Obwegeser
48-192-01-07 -
48-192-03-07

1/1



48-192-01-07
12,5 cm / 4 7/8"



48-192-02-07
13 cm / 5 1/8"



48-192-03-07
15 cm / 5 7/8"

TC GOLD



1/2

Obwegeser
48-194-13-07
13 cm / 5 1/8"

1/1



48-196-14-07



48-198-14-07

breites Maul
wide jaw
ampia boca
gueule large
bocca ampia

1/2



Obwegeser
48-196-14-07 -
48-198-14-07
14 cm / 5 4/8"

Knochenformzangen

Bone Contouring Forceps

Pinzas para formar huesos

Pinces pour former os

Pinze per afferrare ossa



Hauthäkchen, Kopfhautklemme

Skin Hooklet, Scalp Clamp

Ganchito para piel, Pinza para cabelludo

Crochet pour peau, Pince pour le cuir chevelu

Gancio per cute, Pinza per cuoio capelluto

Kraniomaxillofaziale Chirurgie

Craniomaxillofacial surgery

Cirurgía cráneo-maxilofacial

Chirurgie crâno-maxillofaciale

Chirurgia cranio-maxillofaciale



Tessier
48-250-19-07

19 cm / 7 1/8"

scharf
sharp
agudo
pointu
acuto

Atrauma



Tessier
48-252-13-07

13,5 cm / 5 3/8"

Nasenspekula

Nasal Specula
Espéculos nasales
Spéculums nasaux
Specoli nasali

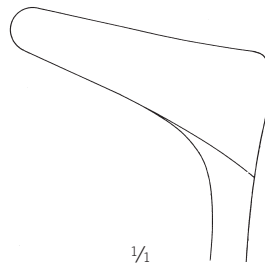

48-261-30-07

13,5 cm / 5 3/8"

Blätter
blades
hojas
lames
lame
35 mm

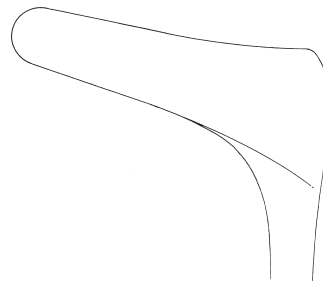

48-261-45-07

14 cm / 5 4/8"

Blätter
blades
hojas
lames
lame
45 mm



48-261-70-07

15,5 cm / 6 1/8"

Blätter
blades
hojas
lames
lame
70 mm



1/2

Tessier
48-261-30-07 -
48-261-70-07

SB

Osteotome

Osteotomes
Osteótomos
Ostéotomes
Osteotomo

Kraniomaxillofaziale Chirurgie

Craniomaxillofacial surgery
Cirugía cráneo-maxilofacial
Chirurgie crânio-maxillofaciale
Chirurgia cranio-maxillofaciale



1/2

Tessier
48-270-02-07 -
48-271-10-07
16 cm / 6 2/8"

48-270-02-07 2 mm	48-270-03-07 3 mm	48-270-05-07 5 mm	48-270-07-07 7 mm
48-270-10-07 10 mm	48-270-14-07 14 mm	48-270-16-07 16 mm	
48-271-05-07 5 mm	48-271-07-07 7 mm	48-271-10-07 10 mm	

1/2

Tessier
48-272-18-07
16 cm / 6 2/8"

1/2

Tessier
48-273-10-07
18 cm / 7 1/8"

18 mm	10 mm

Osteotome

Osteotomes
Osteótomos
Ostéotomes
Osteotomo



Tessier

48-274-10-07 - 48-275-15-07

20 cm / 7 7/8"

zur Transplantatentnahme aus Ilium und Tibia
for taking grafts from ilium and tibia
par sacar transplantes del ilion y la tibia
pour prise de greffon de l'ilion et du tibia
per prendere innesti dall'ileo e tibia

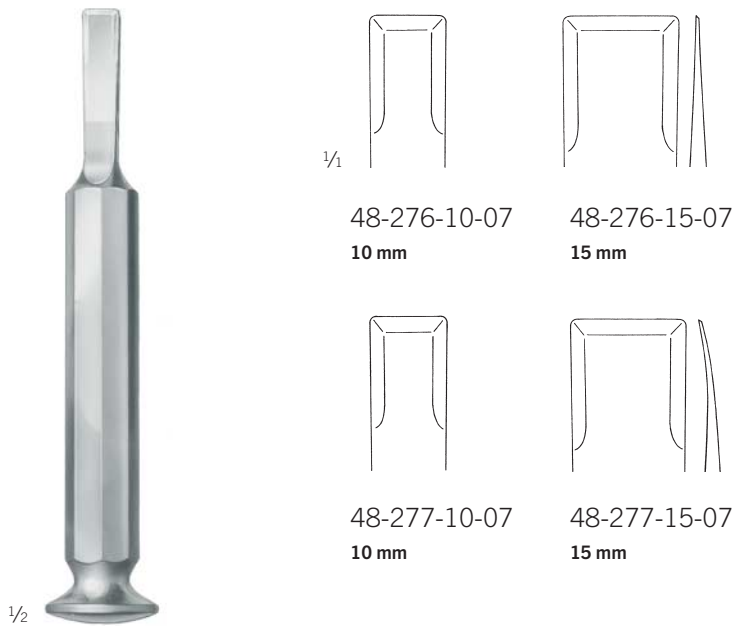

Tessier

48-276-10-07 - 48-277-15-07

16 cm / 6 2/8"

zur Transplantatentnahme aus der Calva
for taking grafts from the calva
par sacar transplantes del calvo
pour prise de greffon du crâne
per prendere innesti dal calvo

Thoraxhaken

Thoracic Retractors
Separadores torácico
Rétracteur thoracique
Divaricatore per torace

Kraniomaxillofaziale Chirurgie

Craniomaxillofacial surgery
Cirugía cráneo-maxilofacial
Chirurgie crânio-maxillofaciale
Chirurgia cranio-maxillofaciale

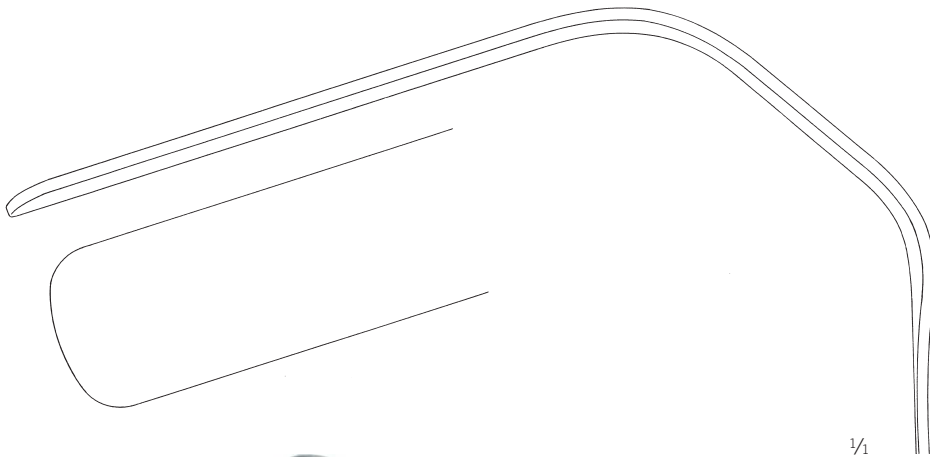

1/1

48-285-20-07

21 cm / 8 2/8"

90 x 22 mm

48-285-28-07

26,5 cm / 10 3/8"

120 x 28 mm



1/2

Tessier

48-285-20-07 -

48-285-28-07



Beckenkamm spatel

Iliac Crest Retractors
Separadores para cresta ilíaca
Rétracteur iliaque
Divaricatore per cresta iliaca

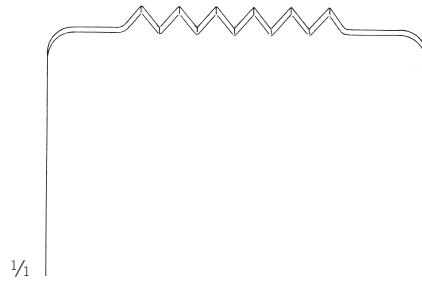

48-287-01-07
16,5 cm / 6 4/8"
36 x 50 mm

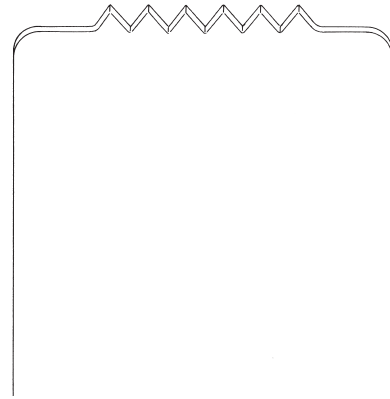

48-287-02-07
17,5 cm / 6 7/8"
52 x 50 mm

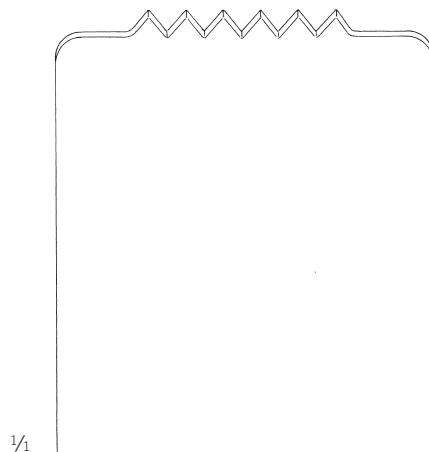

48-287-03-07
17,5 cm / 6 7/8"
59 x 50 mm

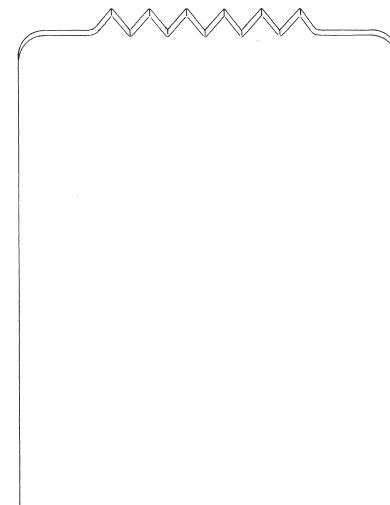

48-287-04-07
18 cm / 7 1/8"
66 x 50 mm



Tessier
48-287-01-07 -
48-287-04-07



Knochenhaltezangen, Knochensplitterzangen, Periostaspatorien

Bone Holding Forceps, Bone Cutting Forceps, Periosteal Elevators

Pinzas para huesos, Cizallas para huesos, Legras para periostio

Pinces pour os, Pinces coupantes à os, Rugine-raspatoires pour périoste

Pinze per ossa, Pinze per ossa, Elevatori periostali

Kraniomaxillofaziale Chirurgie

Craniomaxillofacial surgery

Cirugía cráneo-maxilofacial

Chirurgie crânio-maxillofaciale

Chirurgia cranio-maxillofaciale

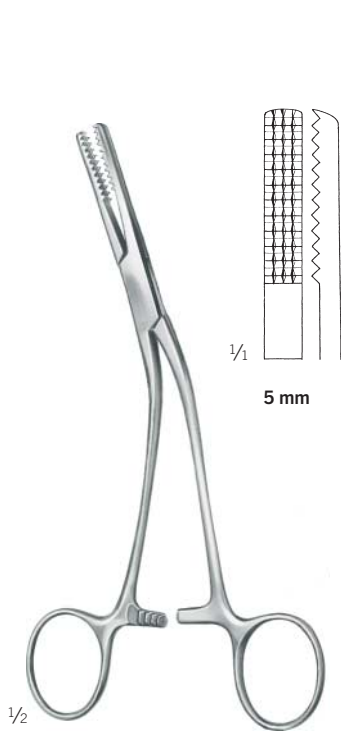

Tessier
48-291-15-07
16,5 cm / 6 1/8"

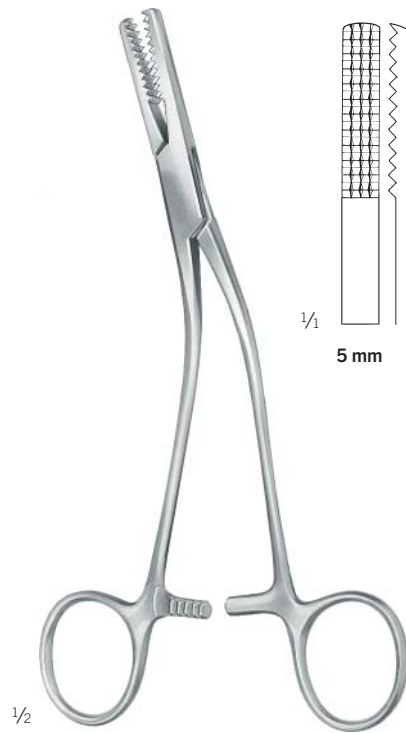

Tessier
48-293-19-07
18 cm / 7 1/8"



Tessier
48-300-20-07
18,5 cm / 7 3/8"
schlankes Modell
slender pattern
modelo delgado
modèle gracile
modello delicato



Tessier
48-301-21-07
22 cm / 8 5/8"

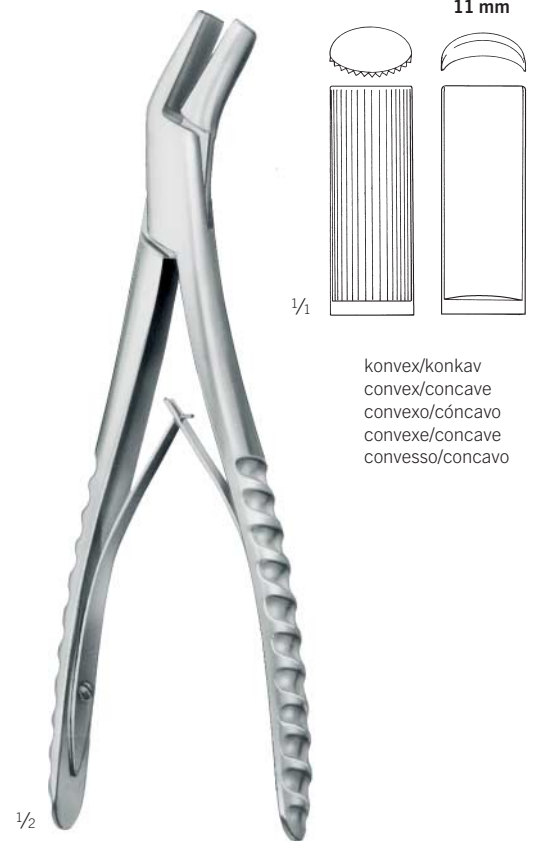

Tessier
48-303-22-07
22 cm / 8 5/8"
Knochenformzange
Bone Contouring Forceps
Pinza para formar huesos
Pince pour former os
Pinza per formare osso

konvex/konkav
convex/concave
convexo/cóncavo
convexe/concave
convesso/concavo

Raspatorien

Periosteal Elevators
Legras
Rugines-raspatoires
Elevatori per periosteo

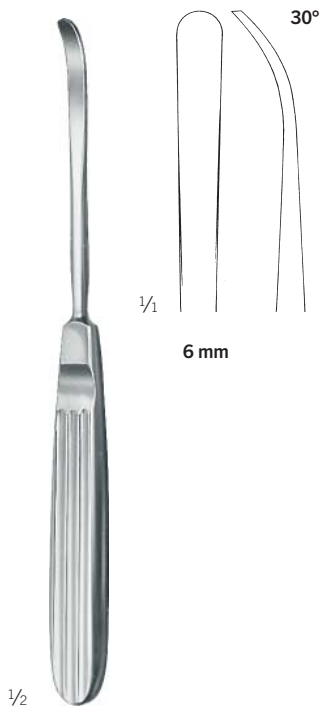

Tessier
48-311-01-07
18 cm / 7 1/8"

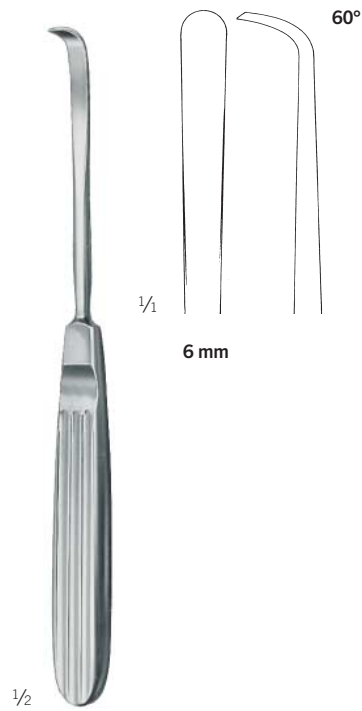

Tessier
48-311-02-07
18 cm / 7 1/8"



Tessier
48-313-01-07-
48-313-02-07
20,5 cm / 8 1/8"



48-313-01-07
12 mm

48-313-02-07
14 mm



Tessier
48-316-21-07
21 cm / 8 2/8"
Ø 2,5 mm



Tessier
48-318-16-07
16,5 cm / 6 4/8"
Ø 4,5 mm



Tessier
48-320-14-07
14 cm / 5 4/8"
Ø 2,0 mm

Spatel

Spatula
Espátulas
Spatules
Spatola

Kraniomaxillofaziale Chirurgie

Craniomaxillofacial surgery
Cirugía cráneo-maxilofacial
Chirurgie crânio-maxillofaciale
Chirurgia cranio-maxillofaciale



1/2

Tessier
48-330-01-07

22 cm / 8 5/8"

10 - 12 mm

konisch, biegsam
conical, malleable
cónico, maleable
conique, malléable
conico, malleabili

SB



1/2

Tessier
48-330-02-07

22 cm / 8 5/8"

15 - 17 mm

konisch, biegsam
conical, malleable
cónico, maleable
conique, malléable
conico, malleabili

SB



1/2

Tessier
48-330-03-07

22 cm / 8 5/8"

20 - 22 mm

konisch, biegsam
conical, malleable
cónico, maleable
conique, malléable
conico, malleabili

SB

Weichteilhaken

Soft Tissue Retractors

Separadores para partes blandas

Ecarteurs pour parties molles

Divaricatori per tessuti molli

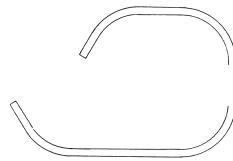

48-331-02-07

15 cm / 5 7/8"

20 x 13 / 30 x 15 mm

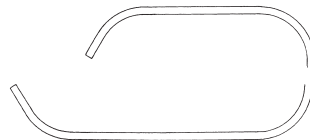

48-331-03-07

15,5 cm / 6 1/8"

28 x 13 / 36 x 15 mm

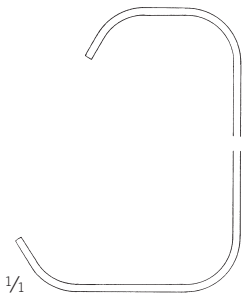

19 x 7 / 29 x 10 mm

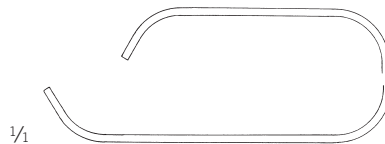

48-331-04-07

15,5 cm / 6 1/8"

33 x 12 / 43 x 15 mm

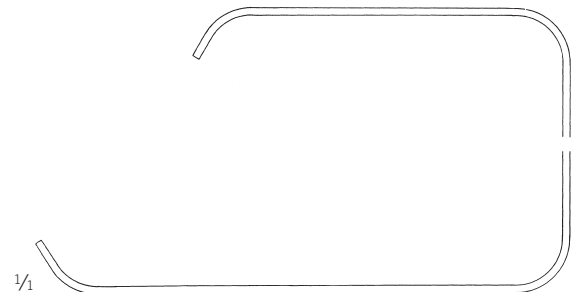

50 x 12 / 68 x 16 mm



Tessier
48-331-01-07
15 cm / 5 7/8"

SB



Tessier
48-331-02-07 -
48-331-04-07

SB



Tessier
48-331-05-07
16 cm / 6 2/8"

SB

Weichteilhaken

Soft Tissue Retractors
Separadores para partes blandas
Ecarteurs pour parties molles
Divaricatori per tessuti molli

Kraniomaxillofaziale Chirurgie

Craniomaxillofacial surgery
Cirugía cráneo-maxilofacial
Chirurgie crânio-maxillofaciale
Chirurgia cranio-maxillofaciale

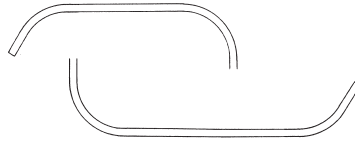

48-333-03-07

15 cm / 5 ⁷/₈"

30 x 12 / 38 x 16 mm

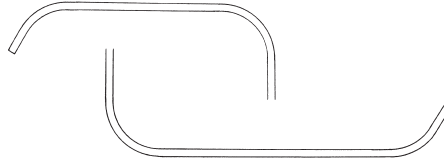

48-333-04-07

15 cm / 5 ⁷/₈"

35 x 12 / 45 x 16 mm

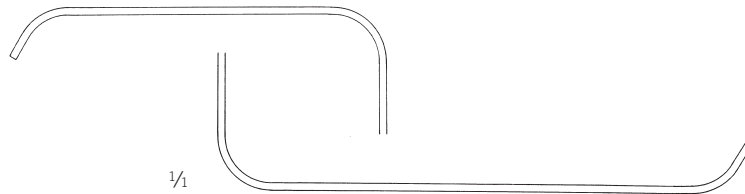

48-333-05-07

16 cm / 6 ²/₈"

50 x 12 / 70 x 16 mm

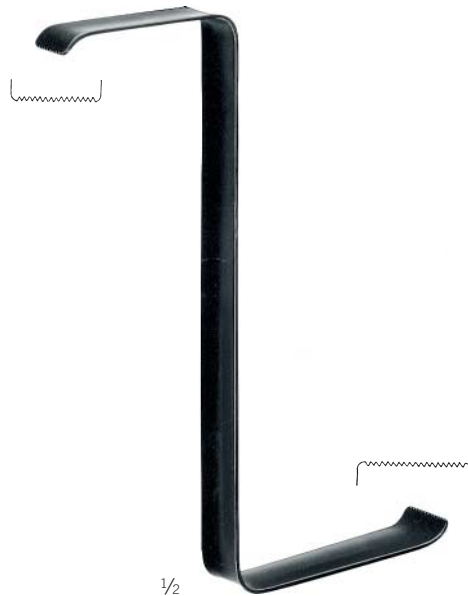

Tessier

48-333-03-07 -

48-333-05-07

SB

Weichteilhaken

Soft Tissue Retractors

Separadores para partes blandas

Ecarteurs pour parties molles

Divaricatori per tessuti molli

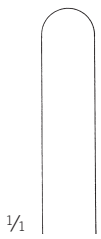

Fig. 1
48-335-01-07
8 mm

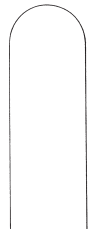

Fig. 2
48-335-02-07
10 mm

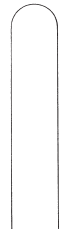

Fig. 3
48-335-03-07
7 mm

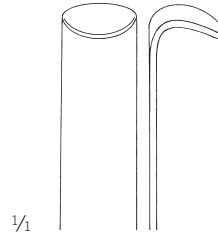

Fig. 4
48-335-04-07
10 mm



Fig. 5
48-335-05-07
8 mm

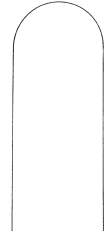

Fig. 6
48-335-06-07
12 mm



Tessier
48-335-01-07 -
48-335-03-07
12,5 cm / 4 7/8"

SB



Tessier
48-335-04-07 -
48-335-06-07
12,5 cm / 4 7/8"

SB

Osteotome

Osteotomes
Osteótomos
Ostéotomes
Osteotomo

Kraniomaxillofaziale Chirurgie

Craniomaxillofacial surgery
Cirugía cráneo-maxilofacial
Chirurgie crânio-maxillofaciale
Chirurgia cranio-maxillofaciale



Tessier
48-340-18-07
19 cm / 7 ⁴/₈"

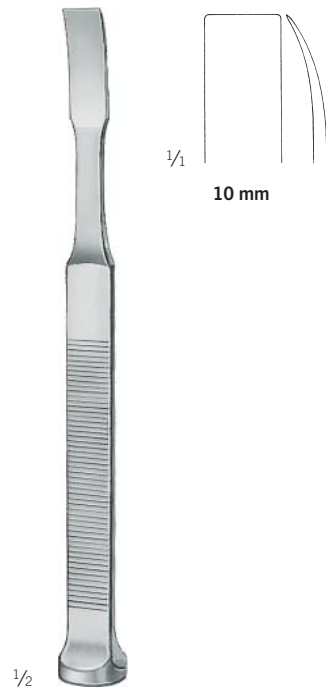

Tessier
48-341-18-07
18 cm / 7 ¹/₈"

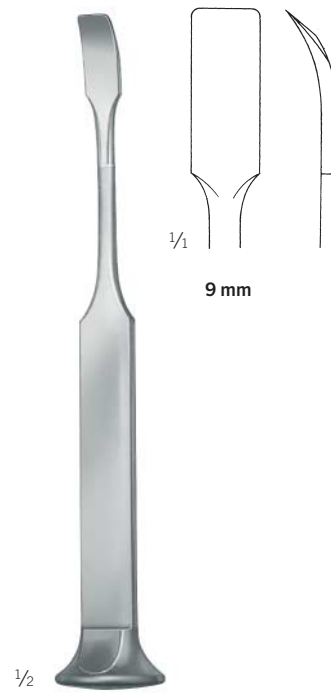

Tessier-Kawamoto
48-345-18-07
18 cm / 7 ¹/₈"
Retromaxillary chisel



48-350-24-07
22 cm / 8 ⁵/₈"

Präparierscheren, Drahtscheren

Dissecting Scissors, Wire Cutting Scissors

Tijeras para preparaciones, Tijeras para alambre

Ciseaux à dissection, Ciseaux à couper le fil

Forbici per dissezione, Tronchesino

TC GOLD



Tessier
48-351-13-07

13 cm / 5 1/8"

Unterminierschere
Undermining Scissors
Tijera para minar
Ciseaux à tunéliser
Forbici per tunnelare



Tessier
48-352-14-07

15 cm / 5 7/8"

TC GOLD

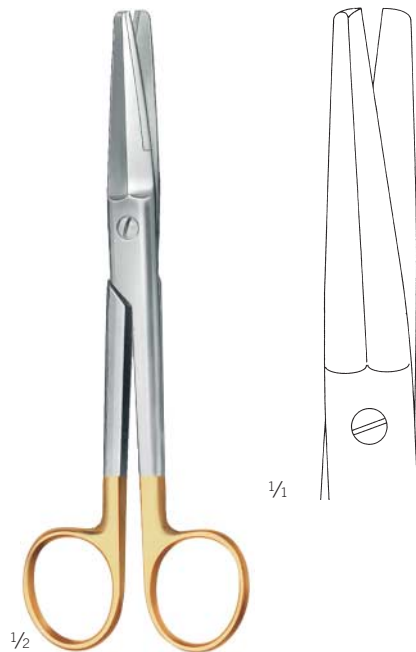

Tessier
48-354-16-07

16,5 cm / 6 4/8"

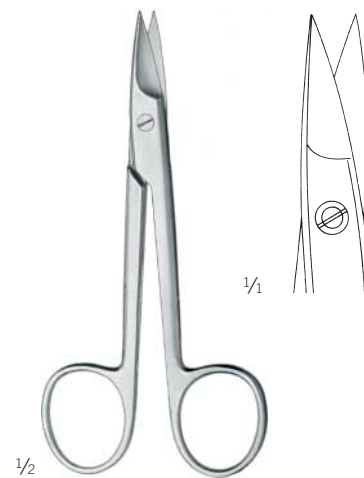

Tessier
48-356-16-07

12 cm / 4 6/8"

Repositionszangen

Disimpaction Forceps
Pinzas de reposición
Pince à repositionner
Pinze per riduzione

Kraniomaxillofaziale Chirurgie

Craniomaxillofacial surgery
Cirugía cráneo-maxilofacial
Chirurgie crânio-maxillofaciale
Chirurgia cranio-maxillofaciale



1/2

Tessier
48-360-01-07 -
48-362-02-07
23 cm / 9"

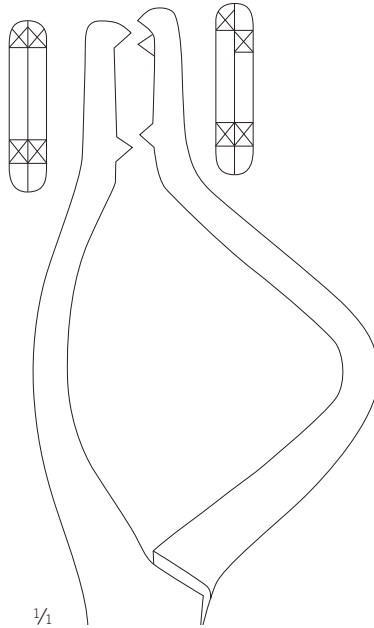

1/1

48-360-01-07

links, für Kinder
left, for children
izquierda, para niños
gauche, pour enfants
sinistra, per bambini

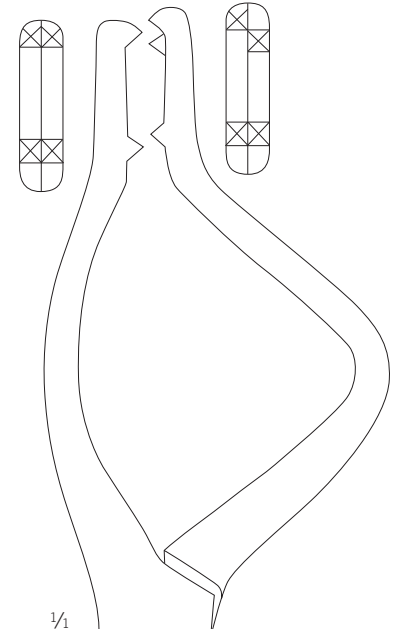

1/1

48-360-02-07

links, für Erwachsene
left, for adults
izquierda, para adultos
gauche, pour adultes
sinistra, per adulti

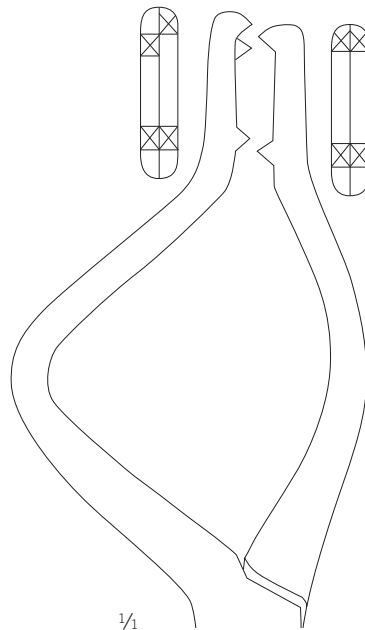

1/1

48-362-01-07

rechts, für Kinder
right, for children
derecha, para niños
droite, pour enfants
destraper bambini

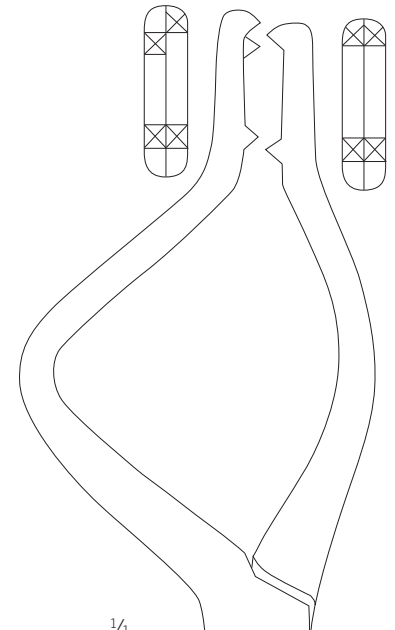

1/1

48-362-02-07

rechts, für Erwachsene
right, for adults
derecha, para adultos
droite, pour adultes
destra, per adulti

Schieblehre, Knochenhaken

Caliper, Bone Hook
Calibre, Gancho para huesos
Calibre, Crochet pour os
Calibro, Gancio per ossa

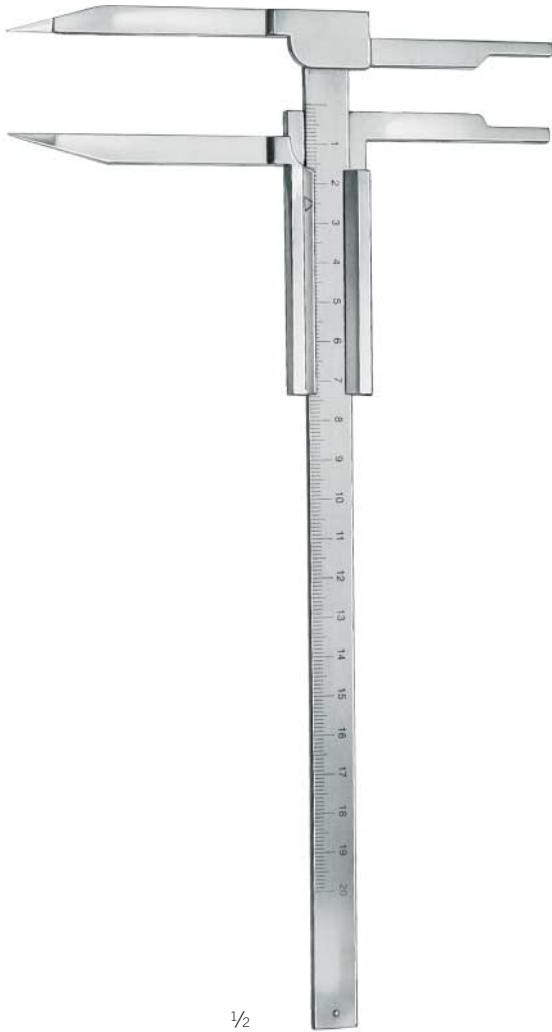

1/2

Tessier
48-370-26-07
26 cm / 10 ²/₈"
Messbereich
effective range
alcance eficaz
série effectif
rango effective
200 mm



1/2

Tessier
48-371-18-07
19 cm / 7 ⁴/₈"
schwarz verchromt
black chromium-plated
cromado en negro
chromé noir
cromato nero

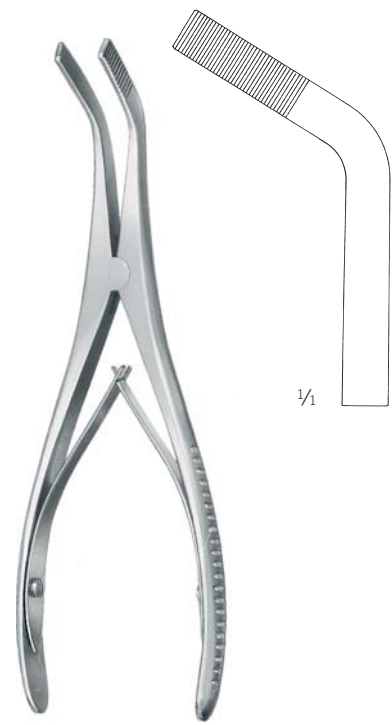

1/2

Tessier
48-376-18-07
17 cm / 6 ⁶/₈"
Spreizzange
Spreading Forceps
Pinza de expansión
Pince à écarter
Pinze per allargare

Mobilisierhaken, Raspatorien

Mobilizing Retractors, Periosteal Elevators
 Separadores de mobilización, Periostótomos
 Crochet de mobilisation, Rugines-raspatoires
 Divaricatori per mobilizzazione, Periostotomi

Kraniomaxillofaziale Chirurgie

Craniomaxillofacial surgery
 Cirugía cráneo-maxilofacial
 Chirurgie crânio-maxillofaciale
 Chirurgia cranio-maxillofaciale

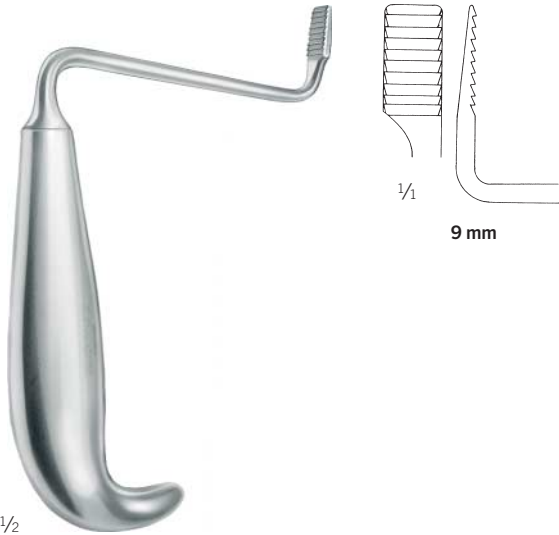

1/2
Tessier
48-380-01-07
 15 cm / 5 7/8"
 rechts
 right
 derecho
 droit
 destra



1/2
Tessier
48-380-02-07
 15 cm / 5 7/8"
 links
 left
 izquierdo
 gauche
 sinistra



1/2
Marchac
48-400-07-07 -
48-400-12-07
 16 cm / 6 3/8"

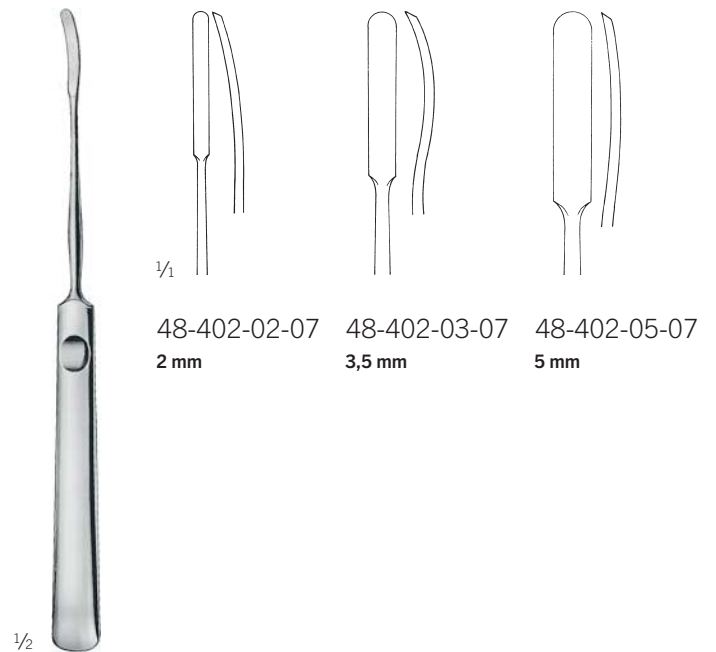

1/2
Marchac
48-402-02-07 -
48-402-05-07
 17 cm / 6 6/8"

Schablonen, Messlehre, Elevatorien

Templates, Caliper, Elevators

Plantillas, Caliper, Elevadores

Gabarits, Calibre, Elévateurs

Sagome, Calibro, Elevatori



1/2

Marchac
48-405-00-07

Frontschablonen
Frontal Templates
Plantillas frontales
Gabarit frontal
Sagome frontali
für Kleinkinder
for infants
para bebés
pour bébés
per neonati



Marchac
48-405-01-07

Frontschablonen
Frontal Templates
Plantillas frontales
Gabarit frontal
Sagome frontali
für Kinder und Erwachsene
for children and adults
para niños y adultos
pour enfants et adultes
per bambini ed adulti



1/2

Marchac
48-420-00-07

Messbereich
effective range
alcance eficaz
série effectif
rango effective
80 mm



1/2

1/1

Steinberg
48-500-18-07

18 cm / 7 1/8"

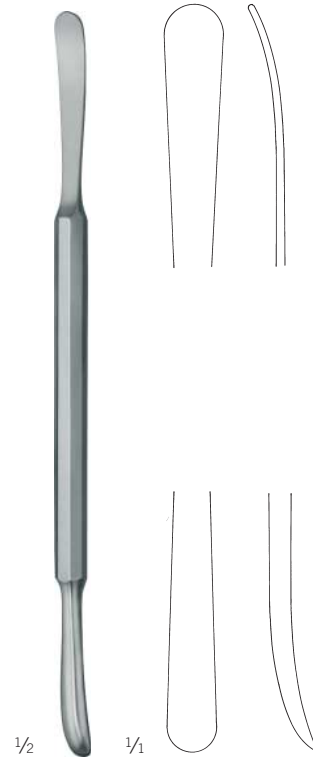

1/2

1/1

Steinberg
48-506-20-07

19,5 cm / 7 5/8"

Elevatorien

Elevators
Elevadores
Elévateurs
Elevatori

Kraniomaxillofaziale Chirurgie

Craniomaxillofacial surgery
Cirugía cráneo-maxilofacial
Chirurgie crânio-maxillofaciale
Chirurgia cranio-maxillofaciale

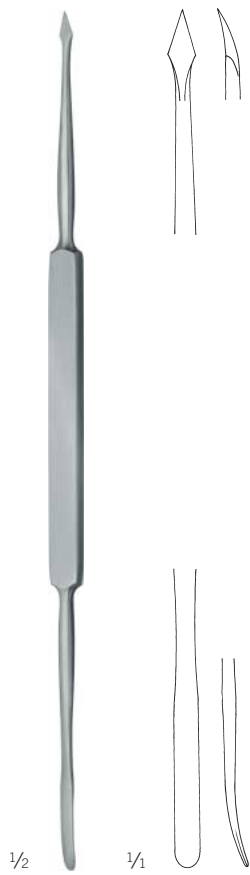
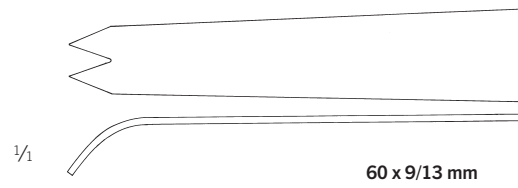

Steinberg
48-525-23-07
22,5 cm / 8 ⁷/₈"

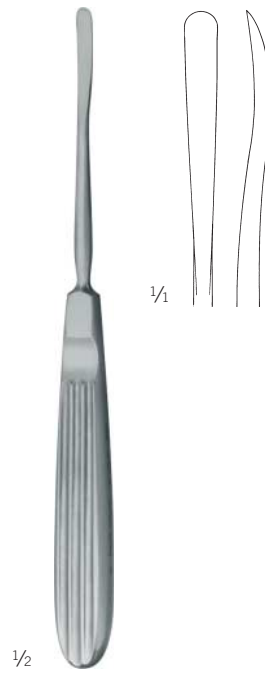

Steinberg
48-531-19-07
18,5 cm / 7 ²/₈"



Steinberg
48-541-60-07
22 cm / 8 ⁵/₈"

Ösenzange

Eyelet forceps
Alicate de orificios
Pince de trous
Pinza di fori

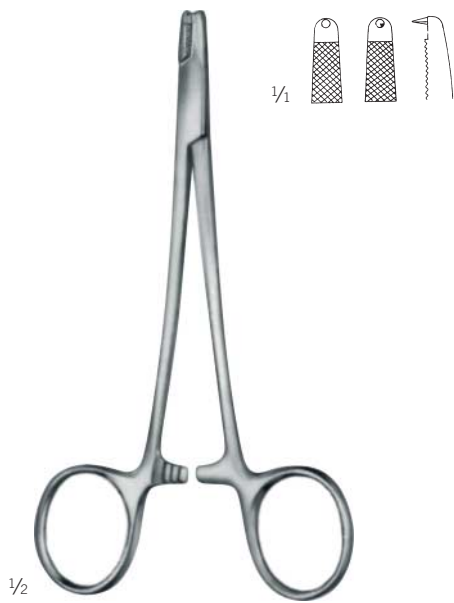
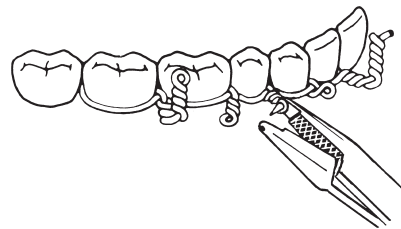
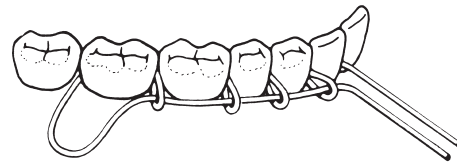
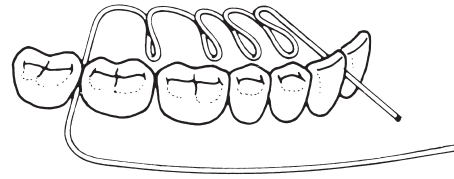

1/2

Obwegeser
48-756-15-07
15 cm / 5 7/8"

Aspirations-Dissektor, Osteotome

Suction Dissector, Osteotomes
 Disecador de aspiración, Osteótomos
 Dissecteur à aspiration, Osteotomes
 Dissettore a aspirazione, Osteotomi

Kraniomaxillofaziale Chirurgie

Craniomaxillofacial surgery
 Cirugía cráneo-maxilofacial
 Chirurgie crânio-maxillofaciale
 Chirurgia cranio-maxillofaciale



1/2

Marchac
 50-430-19-07
 19 cm / 7 1/8"



1/2

Marchac
 50-440-04-07 -
 50-440-08-07
 18,5 cm / 7 3/8"

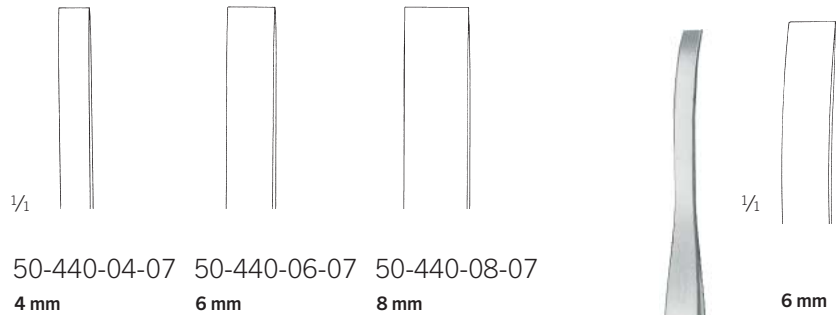

1/1

50-440-04-07
 4 mm

50-440-06-07
 6 mm

50-440-08-07
 8 mm

1/1

6 mm

1/2

Marchac
 50-441-06-07
 18,5 cm / 7 3/8"



1/2

Marchac
 50-446-19-07
 20 cm / 7 7/8"

1/1



1/2

Marchac
 50-450-17-07
 17,5 cm / 6 7/8"
 Knochenspreizzange
 Bone Expander
 Pinza para separar huesos
 Pince pour séparer os
 Pinza per separare ossa

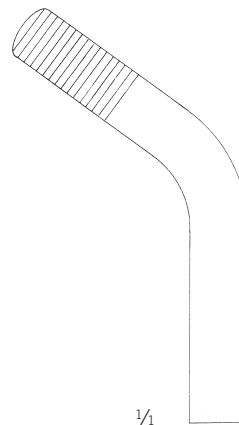

1/1

Instrumentarium Arnett FAB Orthognathie-System

Instrumentation Arnett FAB Orthognathic System

Instrumental sistema ortognático FAB Arnett

Instruments Arnett pour système d'orthognathie FAB

Strumenti per sistema di ortognazia Arnett FAB



Arnett
48-701-22-07

22 cm / 8 5/8"

Ramus-Elevatorium
Ramus Elevator
Elevador de rama
Élévateur pour rama
Elevatore per ramo



Arnett
48-703-19-07

19 cm / 7 4/8"

Kürette
Curette
Cucharillas
Curette
Curette



Arnett
48-704-22-07

20 cm / 7 7/8"

BSSO Lingual-Retraktor
BSSO Lingual retractor
Retractor lingual OSB
Rétracteur lingual BSSO
Separatore linguale BSSO

Fz

Instrumentarium Arnett FAB Orthognathie-System

Instrumentation Arnett FAB Orthognathic System
Instrumental sistema ortognático FAB Arnett
Instruments Arnett pour système d'orthognathie FAB
Strumenti per sistema di ortognazia Arnett FAB

Kraniomaxillofaziale Chirurgie

Craniomaxillofacial surgery
Cirugía cráneo-maxilofacial
Chirurgie crânio-maxillofaciale
Chirurgia cranio-maxillofaciale



Arnett
48-705-14-07

20 cm / 7 7/8"

BSSO TMJ-Platzierer
BSSO Condylar seating instrument
Posicionador ATM OSB
Instrument de positionnement ATM BSSO
Posizionatore per TMJ BSSO



Arnett
48-706-18-07

17 cm / 6 5/8"

Mandibular-Reaktor
Mandibular body retractor
Retractor mandibular
Rétracteur pour mandibule
Separatore mandibolare



Arnett
48-707-14-07

16,5 cm / 6 1/2"

Maxilläre Sinus-Kürette
Maxillary sinus curette
Cureta para seno maxilar
Curette pour sinus maxillaire
Curetta per seno mascellare

Instrumentarium Arnett FAB Orthognathie-System

Instrumentation Arnett FAB Orthognathic System

Instrumental sistema ortognático FAB Arnett

Instruments Arnett pour système d'orthognathie FAB

Strumenti per sistema di ortognazia Arnett FAB

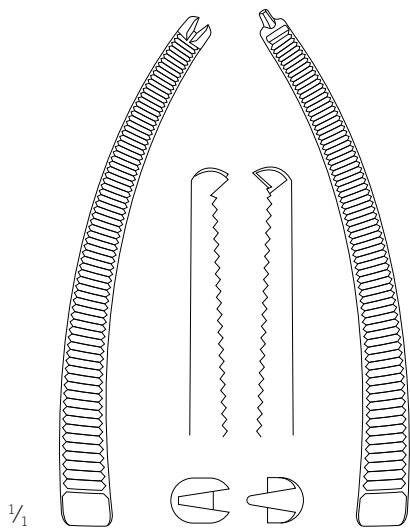

Arnett
48-708-01-07

Koronoid-Reaktor
Coronoid retractor
Retractor de coronoides
Rétracteur coronoïde
Separatore per coronoide

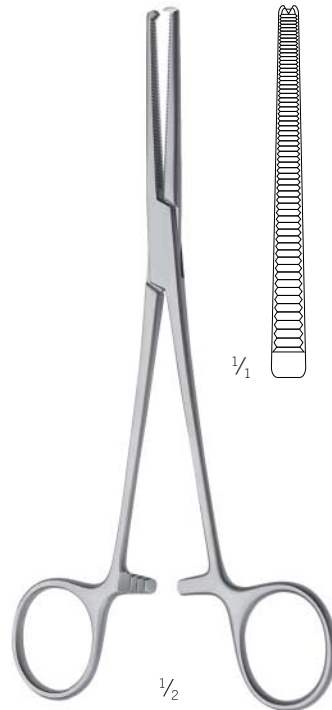
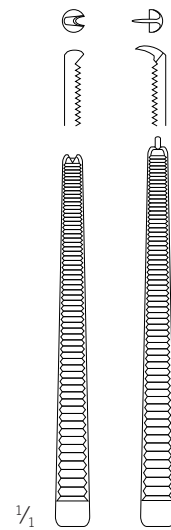

Arnett
48-708-14-07

18,5 cm / 7 2/8"
Knochenklemme
Bone Forceps
Pinza para huesos
Pince pour os
Pinza per ossa



Arnett
48-709-18-07

20 cm / 7 7/8"
Le Fort I Posterior-Reaktor
Le Fort I posterior retractor
Retractor posterior Le Fort I
Le Fort I Rétracteur postérieur
Separatore posteriore Le Fort I

Instrumentarium Arnett FAB Orthognathie-System

Instrumentation Arnett FAB Orthognathic System

Instrumental sistema ortognático FAB Arnett

Instruments Arnett pour système d'orthognathie FAB

Strumenti per sistema di ortognazia Arnett FAB

Kraniomaxillofaziale Chirurgie

Craniomaxillofacial surgery

Cirurgía cráneo-maxilofacial

Chirurgie crâno-maxillofaciale

Chirurgia cranio-maxillofaciale



Arnett 48-711-22-07

22,5 cm / 8 7/8"

DBSSO / Le Fort I
Nerv-Dissektor

BSSO / Le Fort I
Nerve dissector

Disecador para
nervios OSB / Le Fort I

DBSSO / Le Fort I
Dissecteur de nerf

Dissettore per nervi
BSSO / Le Fort I

Arnett 48-711-23-07

23 cm / 9"

BSSO Alveolarnerv-
Dissektor

BSSO Alveolar
nerve dissector

Disecador para
nervio alveolar OSB

Dissecteur de nerf
alvéolaire BSSO

Dissettore per nervo
alveolare BSSO

Arnett 48-711-24-07

23 cm / 9"

BSSO Alveolarnerv-
Dissektor

BSSO Alveolar
nerve dissector

Disecador para
nervio alveolar OSB

Dissecteur de nerf
alvéolaire BSSO

Dissettore per nervo
alveolare BSSO

Arnett 48-711-25-07

23 cm / 9"

Le Fort I / BSSO Retraktor
für Inzissionsverschluss

Le Fort I / BSSO Retractor
for incision closure

Retractor Le Fort I /
OSB para cierre de incisiones

Le Fort I / Rétracteur BSSO
pour fermeture d'incision

Separatore Le Fort I /
BSSO per chiusura incisione

Arnett 48-712-12-07

20 cm / 7 7/8"

Le Fort I Septum-
Elevatorium

Le Fort I Septum
elevator

Elevador para
septo Le Fort I

Le Fort I Élévateur
pour septum

Elevatore setto
Le Fort I

Instrumentarium Arnett FAB Orthognathie-System

Instrumentation Arnett FAB Orthognathic System

Instrumental sistema ortognático FAB Arnett

Instruments Arnett pour système d'orthognathie FAB

Strumenti per sistema di ortognazia Arnett FAB



Arnett
48-714-20-07

19,5 cm / 7 ⁵/₈"

BSSO Nerv-Retractor
BSSO Nerve retractor
Retractor para nervios OSB
Rétracteur de nerf BSSO
Separatore nervi BSSO

Arnett
48-715-42-07

22,5 cm / 8 ⁷/₈"

Le Fort I Oberlippen-Retractor
Le Fort I Upper lip retractor
Retractor para labio superior Le Fort I
Le Fort I Écarteur pour lèvre supérieure
Separatore labbro superiore Le Fort I

Arnett
48-716-22-07 - 48-716-55-07

22,5 cm / 8 ⁷/₈"

Wangen- und Lippen-Retractor
Cheek / lip retractor
Retractor para mejillas y labios
Écarteur des lèvres et joues
Separatore per guance e labbra

Instrumentarium Arnett FAB Orthognathie-System

Instrumentation Arnett FAB Orthognathic System
Instrumental sistema ortognático FAB Arnett
Instruments Arnett pour système d'orthognathie FAB
Strumenti per sistema di ortognazia Arnett FAB

Kraniomaxillofaziale Chirurgie

Craniomaxillofacial surgery
Cirugía cráneo-maxilofacial
Chirurgie crânio-maxillofaciale
Chirurgia cranio-maxillofaciale

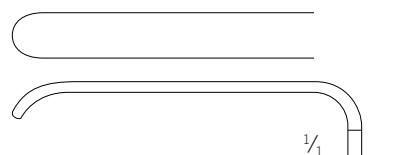

6,5 x 45 mm



1/2

Arnett
48-717-42-07
22 cm / 8 5/8"

Kinnosteotomie-Retraktor
Chin osteotomy retractor
Retractor para osteotomía mentoniana
Rétracteur pour génioplastie
Separatore per osteotomia del mento

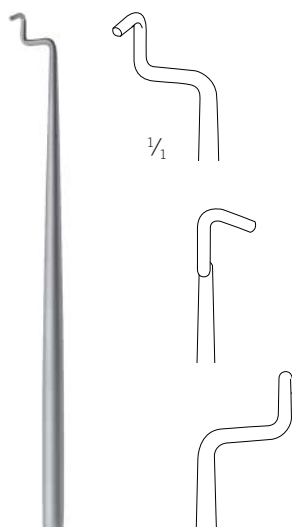

1/2

Arnett
48-723-22-07
22 cm / 8 5/8"

Le Fort I Interdental-Retraktor
Le Fort I Interdental retractor
Retractor interdental Le Fort I
Le Fort I Rétracteur interdenteaire
Separatore interdenteaire Le Fort I

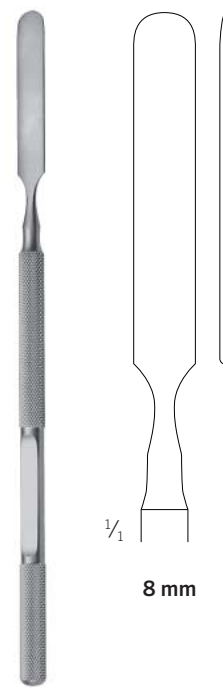

1/2

Arnett
48-725-18-07
18 cm / 7 1/8"

Interdental-Osteotom
Interdental osteotome
Osteótomo interdental
Ostéotome interdenteaire
Osteotomo interdenteaire

Instrumentarium Arnett FAB Orthognathie-System

Instrumentation Arnett FAB Orthognathic System
 Instrumental sistema ortognático FAB Arnett
 Instruments Arnett pour système d'orthognathie FAB
 Strumenti per sistema di ortognazia Arnett FAB



48-726-08-07
7 mm

48-726-15-07
14 mm

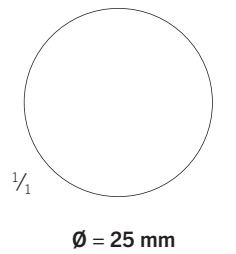

Ø = 25 mm



Arnett
48-727-20-07
20 cm / 7 7/8"

Hammer
Mallet
Martillo
Maillets
Martello

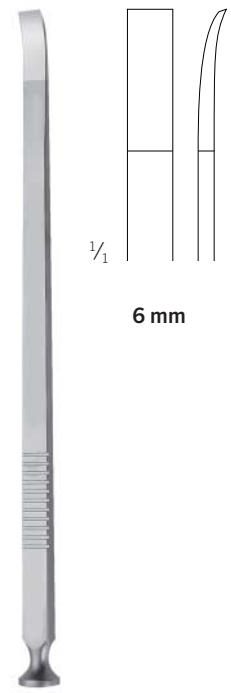

Arnett
48-728-18-07
18 cm / 7 1/8"

Pterygoid-Osteotom
Pterygoid osteotome
Osteótomo pterigoideo
Ostéotome ptérygoïde
Osteotomo per pterigoido

Fz

Instrumentarium Arnett FAB Orthognathie-System

Instrumentation Arnett FAB Orthognathic System
Instrumental sistema ortognático FAB Arnett
Instruments Arnett pour système d'orthognathie FAB
Strumenti per sistema di ortognazia Arnett FAB

Kraniomaxillofaziale Chirurgie

Craniomaxillofacial surgery
Cirugía cráneo-maxilofacial
Chirurgie crânio-maxillofaciale
Chirurgia cranio-maxillofaciale

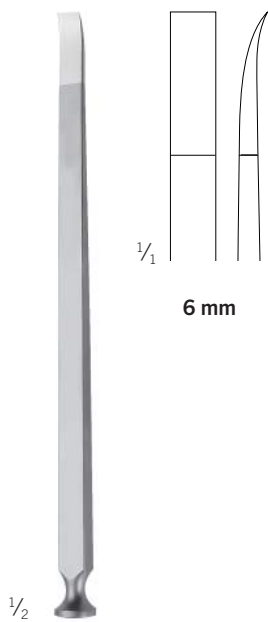
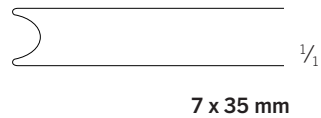

Arnett
48-728-19-07

16 cm / 6 2/8"

BSSO Split-Osteotom
BSSO Splitting osteotome
Osteótomo Split OSB
Ostéotome de dédoublement BSSO
Osteotomo BSSO



Arnett
48-729-55-07

22 cm / 8 5/8"

BSSO Transoral-Retraktor
BSSO Transoral retractor
Retractor transoral OSB
Rétracteur transoral BSSO
Separatore transorale BSSO



Arnett
48-731-14-07

14,5 cm / 5 6/8"

Meßschieber
Caliper
Calibre
Calibre
Calibro a corsoio

Instrumentarium Arnett FAB Orthognathie-System

Instrumentation Arnett FAB Orthognathic System

Instrumental sistema ortognático FAB Arnett

Instruments Arnett pour système d'orthognathie FAB

Strumenti per sistema di ortognazia Arnett FAB

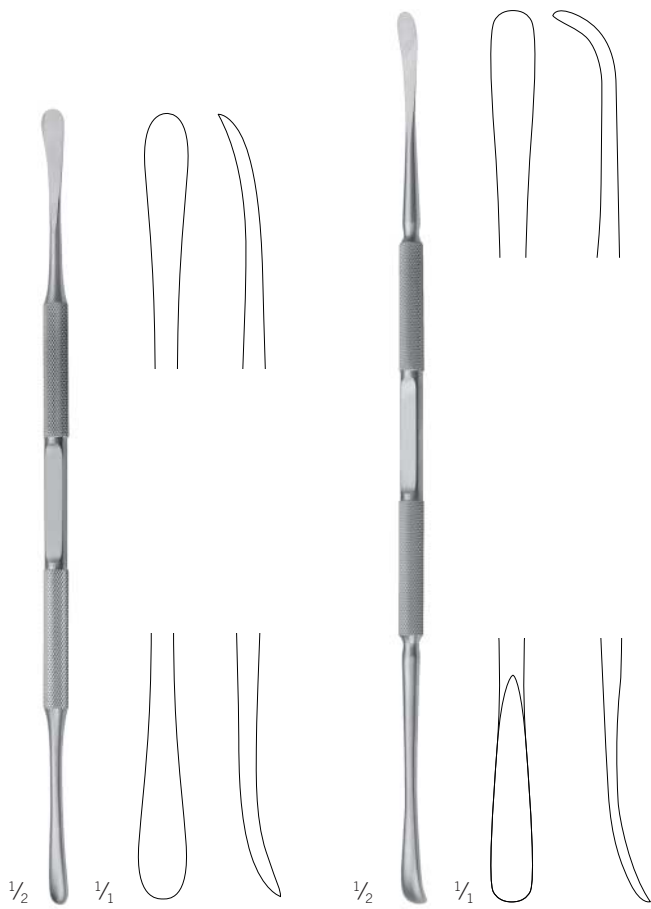

Arnett
48-731-22-07

21 cm / 8 2/8"

Periostelevator
Periosteal elevator
Elevador perióstico
Élévateur à périoste
Elevatore per perioste



Arnett
48-731-25-07

24 cm / 9 4/8"

Periostelevator
Periosteal elevator
Elevador perióstico
Élévateur à périoste
Elevatore per perioste



8,5 mm

Arnett
48-735-19-07

19 cm / 7 4/8"

Retraktor für Kinnosteotomie
Midline flap retractor
Retractor para osteotomía mentoniana
Rétracteur pour génioplastie
Separatore per osteotomia del mento

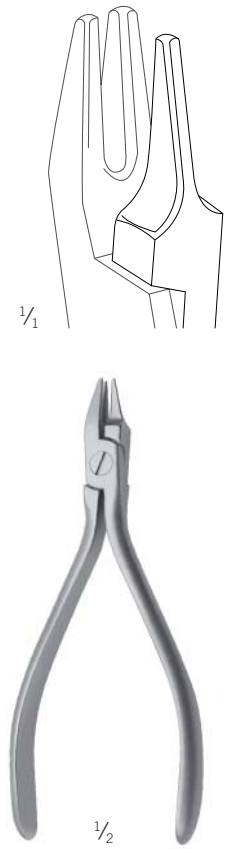

Arnett
48-738-12-07

12,5 cm / 4 7/8"

Plattenbiegezange
Plate bending forceps
Alicate para doblar placas
Pince de pliage
Pinza per piegare placche

Instrumentarium Arnett FAB Orthognathie-System

Instrumentation Arnett FAB Orthognathic System
Instrumental sistema ortognático FAB Arnett
Instruments Arnett pour système d'orthognathie FAB
Strumenti per sistema di ortognazia Arnett FAB

Kraniomaxillofaziale Chirurgie

Craniomaxillofacial surgery
Cirugía cráneo-maxilofacial
Chirurgie crâno-maxillofaciale
Chirurgia cranio-maxillofaciale

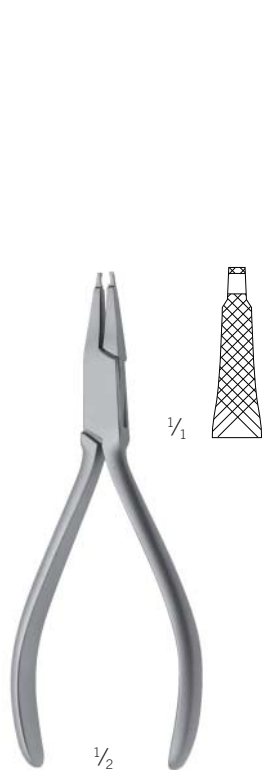

Arnett
48-738-13-07

13 cm / 5 1/8"

Le Fort I Plattenbiegezange
Le Fort I Plate bending forceps
Alicate para doblar placas Le Fort I
Le Fort I Pince de pliage
Pinza per piegare placche Le Fort I

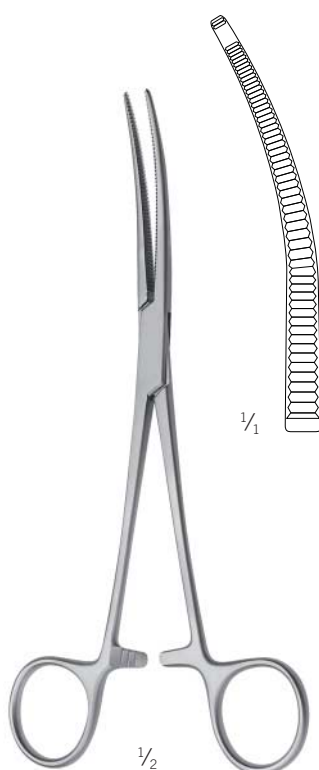

Arnett
48-739-18-07

18,5 cm / 7 2/8"

Plattenhalteklemme
Plate carrier
Pinza para sujetar placas
Pince de maintien
Pinza ferma-placche

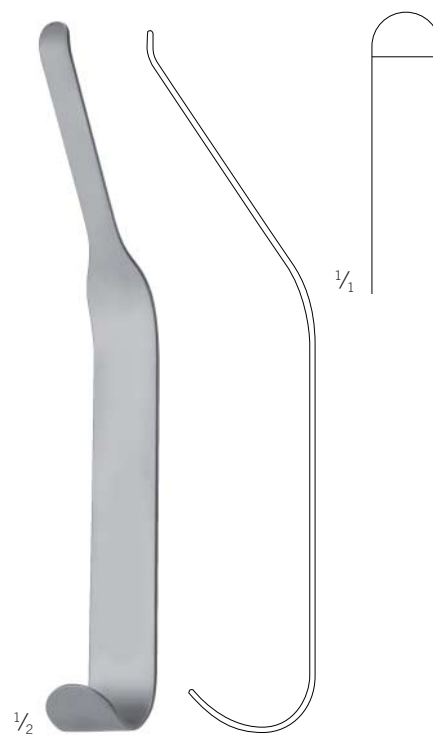

Arnett
48-740-20-07

18,5 cm / 7 2/8"

Le Fort I Retraktor für nasale Mukosa
Le Fort I Nasal mucosa retractor
Retractor Le Fort I para mucosa nasal
Le Fort I Rétracteur pour muqueuse nasale
Separatore Le Fort I per mucosa nasale

Sagittale Ramusosteotomie nach Lindorf

Sagittal ramus osteotomies acc. to Lindorf

Osteotomía sagital de rama mandibular según Lindorf

Ostéotomie sagittale du ramus selon Lindorf

Osteotomia sagittale del ramo secondo Lindorf

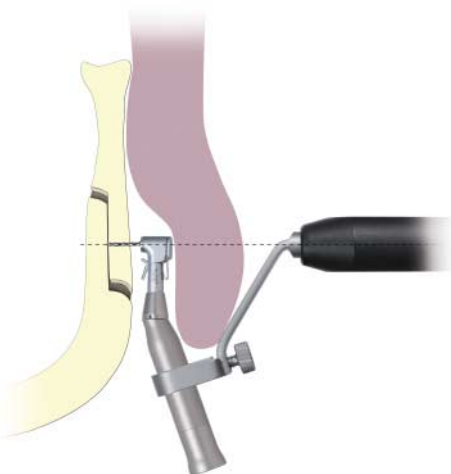
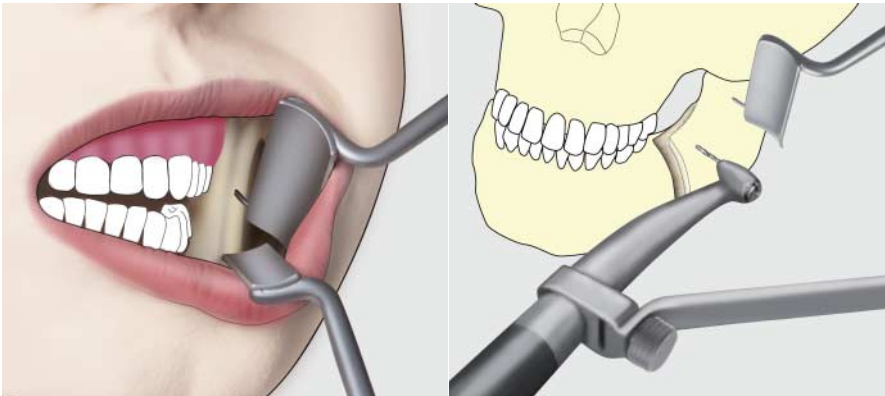

1/2

Lindorf
50-840-00-07

18 cm / 7 1/8"

Enorale Bohr- und Schraubhilfe
Enoral drilling and screwing aid
Ayuda per perforar y atornillar
Aide de forage et vissage
Aiuto per perforare e avvitare

Sagittale Ramusosteotomie nach Lindorf

Sagittal ramus osteotomies acc. to Lindorf
Osteotomía sagital de rama mandibular según Lindorf
Ostéotomie sagittale du ramus selon Lindorf
Osteotomia sagittale del ramo secondo Lindorf

Kraniomaxillofaziale Chirurgie

Craniomaxillofacial surgery
Cirugía cráneo-maxilofacial
Chirurgie crânio-maxillofaciale
Chirurgia cranio-maxillofaciale

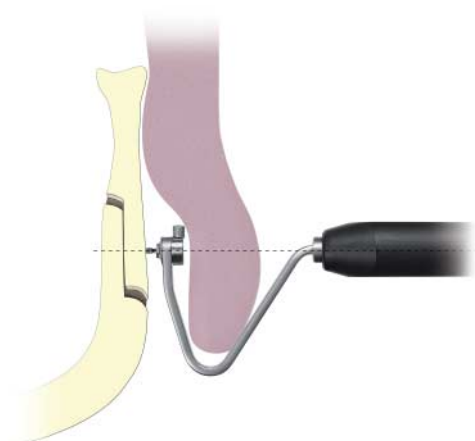
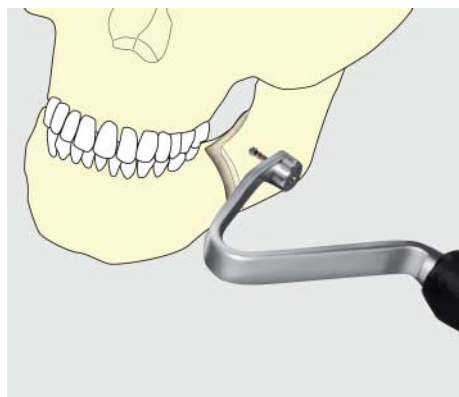

1/2

Einsätze für Schrauben
Blades for screws
Terminales para tornillos
Lames pour vis
Lame per viti

		Centre Drive®	
1,5 mm	● ⊕	50-910-15-07	
2,0/2,3 mm	● ⊕	50-910-20-07	
		Cross Drive	
1,5 mm	● ⊕	50-915-15-07	
2,0/2,3 mm	● ⊕	50-915-20-07	
2,7 mm	○ ⊕	50-915-27-07	

Lindorf
50-841-00-07

18 cm / 7 1/8"

Explantationsinstrument
Explantation instrument
Instrument para explantacion
Instrument d'explantaton
Strumento per espianzazione

Weitere Produkte

Additional Products
Productos adicionales
Produits supplémentaires
Prodotti aggiuntivi

In unserem Hauptkatalog finden Sie eine große Auswahl von Scheren, Pinzetten, Nadelhalter und Standard Wundhaken

Our main catalog contains a wide selection of scissors, tweezers, needle holders and standard surgical retractors.

En nuestro catálogo principal encontrará una amplia selección de tijeras, pinzas, porta-agujas y separadores estándar

Notre catalogue général contient une large variété de ciseaux, pinces, porte-aiguilles et écarteurs standard

Nel nostro catalogo generale è disponibile un'ampia scelta di forbici, pinzette, portaaghi e divaricatori standard

Unser Ordner-System „CMF Osteosynthesis“ enthält die gesamte Palette der KLS-Martin-Implantate und -Instrumente für die Mund-, Kiefer- und Gesichtschirurgie.

Our folder system “CMF Osteosynthesis” contains the full range of KLS-Martin implants and instruments for cranio-Craniomaxillofacial surgery.

Nuestro sistema de carpetas “CMF Osteosynthesis” incluye la gama completa de implantes e instrumentos de KLS-Martin para la cirugía oral y maxilofacial.

Notre système de dossiers «CMF Osteosynthesis» contient l'ensemble de la palette des implants et instruments KLS Martin pour la chirurgie buccale et maxillofaciale.

Il nostro sistema di cartelle “CMF Osteosynthesis” contiene la gamma completa degli impianti e degli strumenti di KLS Martin per la chirurgia orale-maxillo-facciale.

Unser Katalog „Dental/Oral“ enthält die gesamte Palette der KLS-Martin-Dental-Instrumente.

Our catalog “Dental/Oral” contains the full range of KLS-Martin dental instruments.

Nuestro catálogo “Dental/Oral” incluye la gama completa de instrumentos dentales de KLS-Martin.

Notre catalogue «Dental/Oral» contient l'ensemble de la palette des instruments dentaires KLS Martin.

Il nostro catalogo “Dental/Oral” contiene la gamma completa degli strumenti dentali di KLS Martin.

Informationen zu den KLS-Martin-Distraktoren entnehmen Sie bitte den separaten Broschüren.

Please refer to the separate brochures for information about KLS-Martin distactors.

Encontrará información sobre los dispositivos de distracción de KLS-Martin en los folletos específicos.

Veillez vous reporter aux brochures séparées pour obtenir des informations détaillées à propos des dispositifs de distraction KLS Martin.

Per informazioni sui distrattori di KLS Martin, consultare le brochure separate.

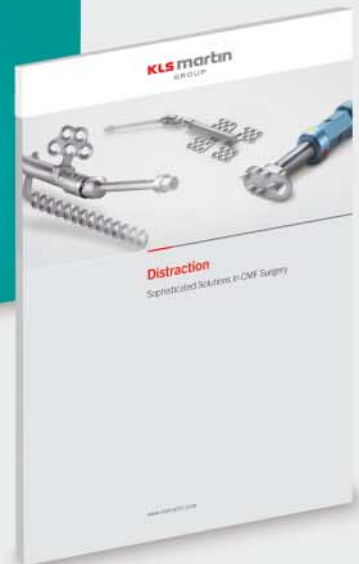
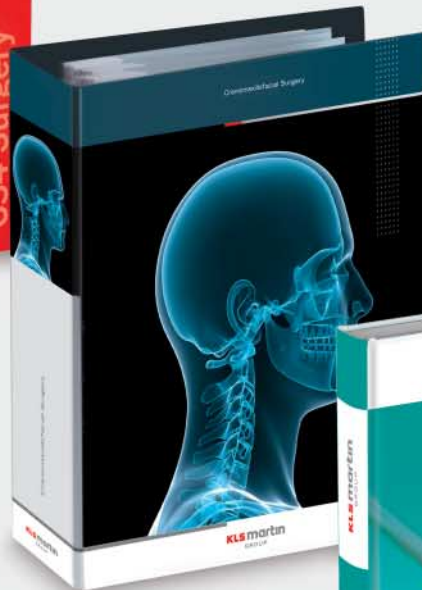

Nummern-Index
Index of order numbers
Índice de números de referencia
Index numérique des références de commande
Elenco dei codici



Nummern-Index

Index of order numbers

Índice de números de referencia

Index numérique des références de commande

Elenco dei codici

11

11-765-18-07	2
11-767-18-07	2
11-769-18-07	2

12

12-276-18-07	3
12-278-18-07	3
12-279-18-07	3

15

15-318-01-07	6
15-318-02-07	6
15-716-01-07	10
15-716-03-07	10

20

20-610-18-07	4
--------------	---

35

35-133-06-07	14
35-133-07-07	14
35-133-09-07	14
35-134-09-07	14
35-134-18-07	14
35-135-18-07	14

37

37-544-03-07	8
37-544-04-07	8
37-544-05-07	9
37-544-06-07	9

38

38-011-16-07	16
38-012-16-07	16
38-013-13-07	16
38-014-00-07	16
38-050-45-09	17
38-050-65-09	17
38-050-80-09	17
38-051-45-07	17
38-103-01-02	18
38-111-02-02	18
38-120-10-04	18
38-127-02-04	18
38-130-50-07	18
38-130-52-07	18
38-130-54-07	18
38-130-56-07	18
38-130-58-07	18
38-130-90-98	18
38-140-13-07	19
38-161-11-07	19

38-161-14-07	19
38-161-92-98	19
38-161-93-98	19
38-171-12-07	19
38-179-16-07	19
38-179-20-07	19
38-196-00-07	20
38-198-00-07	20, 21
38-198-01-07	21
38-198-02-07	21
38-198-03-07	21
38-198-10-07	21
38-198-90-98	21
38-208-00-07	22
38-208-01-07	22
38-208-02-07	22
38-208-03-07	22
38-208-10-07	22
38-212-00-07	23
38-212-01-07	23
38-212-02-07	23
38-212-03-07	23
38-212-04-07	23
38-212-05-07	23
38-212-10-07	23
38-212-50-07	23
38-212-90-98	23
38-222-00-07	24
38-222-01-07	24
38-222-02-07	24
38-222-03-07	24
38-222-10-07	24
38-224-00-07	25
38-224-01-07	25
38-224-02-07	25
38-224-03-07	25
38-237-09-07	26
38-237-11-07	26
38-237-13-07	26
38-237-15-07	26
38-240-00-07	26
38-240-01-07	26
38-240-02-07	26
38-240-03-07	26
38-240-13-07	26
38-243-11-01	27
38-246-14-04	27
38-249-14-01	27
38-251-12-07	27
38-261-13-01	27
38-263-15-01	27
38-265-00-01	27
38-271-15-07	28
38-277-14-07	28
38-281-14-07	28
38-297-01-01	28
38-297-02-01	28
38-350-16-04	29
38-352-15-04	29
38-375-13-01	29

38-375-16-01	29
38-385-19-01	29
38-405-02-07	30
38-405-03-07	30
38-452-17-07	31
38-467-17-07	31
38-468-02-04	31
38-501-24-01	32
38-502-24-01	32
38-503-27-01	33
38-504-27-01	33
38-505-24-01	34
38-507-27-01	34
38-509-21-01	35
38-511-21-01	35
38-513-24-01	35
38-515-24-01	35
38-517-25-01	36
38-519-28-01	36
38-520-01-07	38
38-520-02-07	38
38-520-03-07	39
38-520-04-07	39
38-520-28-01	36
38-523-24-01	37
38-525-01-07	40
38-525-02-07	41
38-526-01-07	40
38-526-02-07	41
38-527-01-07	42
38-527-02-07	42
38-603-40-07	43
38-603-55-07	43
38-603-80-07	43
38-605-22-07	43
38-607-22-07	44
38-611-16-07	44
38-613-08-07	44
38-613-10-07	44
38-614-10-07	45
38-614-20-07	45
38-616-01-07	46
38-616-02-07	46
38-616-10-07	47
38-616-20-07	47
38-618-01-07	48
38-618-02-07	48
38-618-10-07	49
38-618-20-07	49
38-620-10-07	50
38-620-20-07	50
38-630-06-07	51
38-630-07-07	51
38-630-09-07	51
38-630-11-07	51
38-631-05-07	51
38-631-07-07	51
38-631-09-07	51
38-632-01-07	52
38-632-02-07	52

38-633-01-07	52
38-633-02-07	52
38-633-03-07	52
38-633-04-07	52
38-640-21-07	53
38-642-21-07	53
38-684-01-07	7
38-684-02-07	7
38-684-03-07	11
38-684-04-07	11
38-685-00-07	53
38-688-15-07	53
38-690-00-07	53
38-691-01-07	54
38-691-02-07	54
38-693-19-07	54
38-694-20-07	54
38-695-20-07	55
38-696-20-07	55
38-697-01-07	55
38-697-02-07	55
38-700-01-07	56
38-700-02-07	56
38-700-03-07	56
38-701-01-07	56
38-701-02-07	56
38-701-03-07	56
38-711-01-01	57
38-711-02-01	57
38-711-21-07	57
38-713-21-07	57
38-715-19-07	58
38-715-21-07	58
38-715-22	7
38-718-01-07	58
38-718-02-07	58
38-719-01-07	59
38-719-02-07	59
38-720-01-07	59
38-720-02-07	59
38-722-25-07	60
38-723-16-07	60
38-725-01-07	61
38-725-02-07	61
38-725-03-07	61
38-725-04-07	61
38-731-12-07	62
38-733-13-07	62
38-737-17-07	62
38-739-14-07	62
38-741-01-07	63
38-741-02-07	63
38-741-03-07	63
38-745-01-07	64
38-745-02-07	64
38-750-16-07	65
38-751-01-07	65
38-751-02-07	65
38-751-03-07	65
38-780-00-07	66

38-780-01-07	66
38-781-00-07	66
38-781-01-07	66
38-783-01-07	66
38-786-04-07	66
38-786-06-07	66
38-786-08-07	66
38-786-10-07	66
38-786-12-07	66
38-786-14-07	66
38-786-16-07	66
38-790-04-07	67
38-790-06-07	67
38-790-08-07	67
38-791-01-07	67
38-791-03-07	67
38-796-04-07	67
38-796-06-07	67
38-796-08-07	67
38-797-04-07	68
38-797-06-07	68
38-799-06-07	68
38-799-08-07	68
38-810-00-07	68
38-810-01-07	68
38-810-02-07	68
38-810-03-07	68
38-829-00-07	69
38-831-01-07	69
38-831-02-07	69
38-833-18-07	70
38-835-19-07	70
38-837-01-07	71
38-837-02-07	71
38-837-03-07	71
38-837-04-07	71
38-839-18-07	72
38-841-22-07	72
38-843-19-07	72
38-843-99-07	72
38-845-01-07	73
38-845-02-07	73
38-846-20-07	73
38-850-01-07	74
38-850-02-07	74
38-851-16-07	75
38-853-24-07	75
38-855-17-07	75
38-856-19-07	75
38-870-17-07	76
38-875-18-07	76
38-877-00-07	76
38-878-01-07	77
38-878-02-07	77
38-881-07-07	78
38-881-10-07	78
38-883-07-07	78
38-883-11-07	78
38-883-15-07	78
38-885-18-07	78

38-891-01-0779
 38-891-02-0779
 38-893-16-0780
 38-895-05-0780
 38-895-08-0780
 38-899-06-0780
 38-899-08-0780

39

39-100-17-074

48

48-101-16-0781
 48-101-25-0781
 48-101-35-0781
 48-101-42-0781
 48-101-55-0781
 48-101-70-0781
 48-101-80-0781
 48-103-16-0782
 48-103-25-0782
 48-103-35-0782
 48-103-42-0782
 48-103-55-0782
 48-103-70-0782
 48-103-80-0782
 48-107-22-0783
 48-109-22-0783
 48-111-22-0783
 48-113-22-0783
 48-115-01-0784
 48-115-02-0784
 48-117-01-0784
 48-117-02-0784
 48-121-08-0784
 48-121-10-0784
 48-125-15-0784
 48-130-06-0785
 48-130-07-0785
 48-130-09-0785
 48-130-11-0785
 48-132-06-0785
 48-132-07-0785
 48-132-09-0785
 48-132-11-0785
 48-135-21-0786
 48-137-21-0786
 48-140-01-0786
 48-140-02-0786
 48-150-01-0786
 48-150-02-0786
 48-152-05-0787
 48-152-07-0787
 48-152-09-0787
 48-156-04-0787
 48-156-06-0787
 48-156-08-0787
 48-160-08-0488

48-160-12-0488
 48-160-16-0488
 48-162-08-0488
 48-162-12-0488
 48-162-16-0488
 48-162-20-0488
 48-163-01-0789
 48-163-02-0789
 48-164-15-0790
 48-164-20-0790
 48-166-08-0791
 48-166-11-0791
 48-167-08-0791
 48-167-11-0791
 48-168-03-0791
 48-168-04-0791
 48-168-06-0791
 48-170-23-0791
 48-175-15-0792
 48-175-17-0792
 48-177-24-0792
 48-190-11-0793
 48-192-01-0793
 48-192-02-0793
 48-192-03-0793
 48-194-13-0793
 48-196-14-0793
 48-198-14-0793
 48-220-01-0794
 48-220-02-0794
 48-250-19-0795
 48-252-13-0795
 48-261-30-0796
 48-261-45-0796
 48-261-70-0796
 48-270-02-0797
 48-270-03-0797
 48-270-05-0797
 48-270-07-0797
 48-270-10-0797
 48-270-14-0797
 48-270-16-0797
 48-271-05-0797
 48-271-07-0797
 48-271-10-0797
 48-272-18-0797
 48-273-10-0797
 48-274-10-0798
 48-274-15-0798
 48-274-20-0798
 48-274-30-0798
 48-275-10-0798
 48-275-15-0798
 48-276-10-0798
 48-276-15-0798
 48-277-10-0798
 48-277-15-0798
 48-285-20-0799
 48-285-28-0799
 48-287-01-07100

48-287-02-07100
 48-287-03-07100
 48-287-04-07100
 48-291-15-07101
 48-293-19-07101
 48-300-20-07101
 48-301-21-07101
 48-303-22-07101
 48-311-01-07102
 48-311-02-07102
 48-313-01-07102
 48-313-02-07102
 48-316-21-07102
 48-318-16-07102
 48-320-14-07102
 48-330-01-07103
 48-330-02-07103
 48-330-03-07103
 48-331-01-07104
 48-331-02-07104
 48-331-03-07104
 48-331-04-07104
 48-331-05-07104
 48-333-03-07105
 48-333-04-07105
 48-333-05-07105
 48-335-01-07106
 48-335-02-07106
 48-335-03-07106
 48-335-04-07106
 48-335-05-07106
 48-335-06-07106
 48-340-18-07107
 48-341-18-07107
 48-345-18-07107
 48-350-24-07107
 48-351-13-07108
 48-352-14-07108
 48-354-16-07108
 48-356-16-07108
 48-360-01-07109
 48-360-02-07109
 48-362-01-07109
 48-362-02-07109
 48-370-26-07110
 48-371-18-07110
 48-376-18-07110
 48-380-01-07111
 48-380-02-07111
 48-400-07-07111
 48-400-12-07111
 48-402-02-07111
 48-402-03-07111
 48-402-05-07111
 48-405-00-07112
 48-405-01-07112
 48-420-00-07112
 48-500-18-07112
 48-506-20-07112
 48-525-23-07113

48-531-19-07113
 48-541-60-07113
 48-701-22-07116
 48-703-19-07116
 48-704-22-07116
 48-705-14-07117
 48-706-18-07117
 48-707-14-07117
 48-708-01-07118
 48-708-14-07118
 48-709-18-07118
 48-711-22-07119
 48-711-23-07119
 48-711-24-07119
 48-711-25-07119
 48-712-12-07119
 48-714-20-07120
 48-715-42-07120
 48-716-22-07120
 48-716-42-07120
 48-716-55-07120
 48-717-42-07121
 48-723-22-07121
 48-725-18-07121
 48-726-08-07122
 48-726-15-07122
 48-727-20-07122
 48-728-18-07122
 48-728-19-07123
 48-729-55-07123
 48-731-14-07123
 48-731-22-07124
 48-731-25-07124
 48-735-19-07124
 48-738-12-07124
 48-738-13-07125
 48-739-18-07125
 48-740-20-07125
 48-756-15-07114

50

50-242-12-0710
 50-430-19-07115
 50-440-04-07115
 50-440-06-07115
 50-440-08-07115
 50-441-06-07115
 50-446-19-07115
 50-450-17-07115
 50-840-00-07126
 50-841-00-07127
 50-910-15-07127
 50-910-20-07127
 50-915-15-07127
 50-915-20-07127
 50-915-27-07127

Index, alphabetisch
Index, alphabetical
Índice, alfabético
Index alphabétique
Índice, alfabético



A			
Alveolar-Nerv-Dissektor, Arnett	119	Knochenformzange	94, 101
Atr.-Kopfhautklemme, Tessier	95	Knochenhaken, Marchac	115
Atrauma-Muskelklemme, Terry	74	Knochenhaken, Tessier	110
Atrauma-Muskelklemme, Terry	74	Knochenhaltezeange, JVS	58
Äußerer Progeniehaken, Lauer	47, 49, 50	Knochenhaltezeange, JVS	58
		Knochenhaltezeange, Keen	59
B		Knochenhaltezeange, Salyer	60
Beckenkammspatel, Tessier	100	Knochenhaltezeange, Steinhäuser	59
Blattosteotom, Obwegeser	88	Knochenhaltezeange, Wolford	60
Bruststütze z. Mundsperrerr	20	Knochenhaltezeange	101
BSSO/LF1-Nerv-Dissektor, Arnett	119	Knochensplittzerange, Tessier	101
BSSO-Lingual-Re retraktor, Arnett	116	Knochenspreizer, Obwegeser	90
BSSO-Split-Osteotom, Arnett	122, 123	Knochenspreizzeange, Marchac	115
BSSO-TMJ-Platzierer, Arnett	117	Koronoid-Re retraktor, Arnett	118
BSSO-Transoral-Re retraktor, Arnett	123		
C		L	
Centre Drive®, Aufsatz Dental-Ansatz	127	LF1-Interdental-Re retraktor, Arnett	121
Cross-Drive Bit, für ASD	127	LF1-Posterior Re retraktor, Arnett	118
		Lindemann-Fräser	17
D		Lindorf-Bohr-/Schraubhilfe	128
Dolwick-TMJ-Klemme	64	Lindorf-Explantationsinstrument	127
Drahtbogen, Erich, Meterware	53	Lippen- und Wangenhalter	69
Drahteinführinstrument, Terry	75	Lippenhalter, Sternberg	27
Drahtpositionierer, Rowe	53	Lippensperrerr, Oringer	26
Drahtpositionierer	53		
Drahtschere, Tessier	108	M	
Drahtzwickzeange, Obwegeser	93	Mandibula-Ahle, Obwegeser	92
		Mandibular-Re retraktor, Arnett	117
E		Maxilla-Mobilisator	91
Elevator, Arnett	116	Maxilläre Sinus-Kürette, Arnett	117
Elevatorium, Marchac	111	Meißel, Steinhäuser	78
Elevatorium, Obwegeser	53, 86	Messlehre, Marchac	112
Elevatorium, Steinberg	112, 113	Messschieber, Arnett	123
Elevatorium, Steinhäuser	76	Messzirkel	14
Elevatorium, Terry	16	Mobilisationshaken, Tessier	111
Endo-Condyle Unit	11	Mobilisationshaken, Tessier	111
Extraoraler Re retraktor, Eckelt	32	Mobilisierhaken, Smith	73
Extraoraler Re retraktor, Eckelt	33	Mobilisierhaken, Smith	73
Extraoraler Re retraktor	32	Mobilisierhaken, Tessier	57
Extraoraler Re retraktor	33	Mobilisierhaken, Tessier	57
		Mundkeil, Maunder	18
F		Mundkeil, McKesson, für Zahnlose	18
Fassklemme, Hargis	72	Mundkeil, McKesson, L, für Erwachsene	18
Fingerschutz, Langenbeck	18	Mundkeil, McKesson, S, für Kinder	18
Flachzange, Obwegeser	93	Mundkeil, McKesson, S, für Kleinkinder	18
Flachzange, Obwegeser	93	Mundkeil, McKesson, XL, für Erwachsene	18
Flachzange, Obwegeser	93	Mundkeil, Pitha	18
Flachzange, Obwegeser	93	Mundspatel, Kunststoff	29
Fragmentklemme, Obwegeser	89	Mundsperrerr, Davis-Boyle	23
Fragmentklemme, Obwegeser	89	Mundsperrerr, Denhart	19
Frontschablone, Marchac, Jugendliche	112	Mundsperrerr, Dingmann	25
Frontschablone, Marchac, Kinder	112	Mundsperrerr, Heister	19
		Mundsperrerr, Jennings	26
G		Mundsperrerr, Mclvor	24
Gaumen-Osteotom	107	Mundsperrerr, Molt, für Erwachsene	19
Gaumenplatte für Zahnlose	21	Mundsperrerr, Molt, für Kinder	19
Gelenkrepositionierer	52	Mundsperrerr, Neukam	22
Gelenkrepositionierer	52	Mundsperrerr, Roser-König	19
Gummipolster, Paar	31	Mundsperrerr Kilner-Doughty kompl.	20, 21
		Mundsperrerr mit Gelenk, Davis-Boyle	23
H			
Haken, Dingmann-Wilk	58	N	
Hammer, Arnett	122	Nasa-Mucosa-Haken, Arnett	125
Hauthäkchen, Tessier	95	Nasenahe, Tessier	102
		Nasenspekulum, Tessier	96
I		Nasenspekulum, Tessier	96
Innerer Progeniehaken, Lauer	47, 49, 50	Nasenspekulum, Tessier	96
Interdental-Elevator, Arnett	116		
Interdental-Osteotom, Arnett	121	O	
Intraoral-Re retraktor	34, 35, 36	Orbita-Elevatorium	80
		Orbitahaken, Rowe	54
J		Orbitaosteotom, Steinhäuser	80
Jaboma Spalt-Instrumentarium	1-4	Orbitarand-Re retraktor, Donovan	54
		Orbitarand-Re retraktor	54
K		Osteotom, Bauer	66
Keilosteotom, Obwegeser	88	Osteotom, Dunn-Dautrey	67
Kinnhalter, Obwegeser	44, 84	Osteotom, elastisch	91
Klemme, Arnett	118	Osteotom, Epker-Bauer	66
Knochenformzange, konkav/konvex	94	Osteotom, Epker	67, 68
		Osteotom, Marchac	115
		Osteotom, Munro-Dautrey	66
		Osteotom, Obwegeser	91
		Osteotom, Tessier	97, 98, 107
		Osteotom, Wolford	80
		P	
		Palatumspreizer, Turvey	76
		Perforator, Tessier	102
		Periost-Elevatorium	52
		Periost-Elevatorium	52
		Periost-Elevator, Arnett	124
		Periostraspatorium	102
		Piriformis-Haken	72
		Plattenbiegezeange, Arnett	124
		Plattenbiegezeange, LF1, Arnett	125
		Plattenhalte klemme, Arnett	125
		Plattenloch-Haken, Eckelt	58
		Progeniehaken, Metz	45
		Progeniehaken, Schuchardt	45
		Progenierinne, Obwegeser	44, 84
		Progenierinne, Steinhäuser	76
		Pterygoid-Osteotom, Hargis	72
		Pterygoid-Osteotom, Arnett	122
		R	
		Rahmen zum Mundsperrerr	22
		Ramus-Krallenhaken, Lindorf	40, 41
		Ramushaken, Hargis	69
		Ramushaken, Obwegeser	44, 83
		Ramushaken, Steinberg	113
		Ramus klemme, Obwegeser	84
		Ramus klemme, Steinhäuser	77
		Ramusosteotom, Steinhäuser	78
		Ramusraspatorium, Obwegeser	87
		Ramusschieber, Terry	75
		Ramusspreizzeange, Smith	73
		Ramusstripper, Obwegeser	86
		Raspatorium, Obwegeser	51, 52, 85, 86
		Raspatorium, tiefe V-Form	52
		Raspatorium	48
		Repositionszeange, Rowe	56
		Repositionszeange	109
		Repositionsinstrument, Steinhäuser	78
		Re retraktor, Shea	37
		Re retraktor für Kinnosteotomie, Arnett	121
		Re retraktor für Mentalnerv, Arnett	120
		Re retraktor für Oberlippe, Arnett	120
		Re retraktor für BSSO-Inzissionsverschluss	119
		Re retraktor n. Wolford	80
		Re retraktor nach Ishi	38, 39
		S	
		Saugraspatorium, Marchac	115
		Schieblehre, Tessier	110
		Septumelevator, Arnett	119
		Septumosteotom, Obwegeser	87
		Septumosteotom, Terry	75
		Septumosteotom, Tessier	107
		Serviettenhalter, Adams	18
		Side-Step-Haken, Lindorf	40, 41
		Spatel, Tessier	103
		Sperrerr-Rahmen	21, 23, 24
		Spina-Nasalis-Haken, Obwegeser	43, 83
		Spreizzeange, Tessier	110
		Stripper, Hargis	71
		Stripper, Obwegeser	86
		T	
		TC-Drahtzwirbelzange, Obwegeser	93
		TC-Drahtzwirbelzange	93
		TC-Schere, Tessier	108
		Thoraxhaken, Tessier	99
		Ti-Lindemann-Fräser	17
		TMJ-Disc-Klemme, Dolwick	62
		TMJ-Disc-Schere, Dolwick	62
		TMJ-Elevatorium, Dolw.	62
		TMJ-Klemme, Dolwick	64
		TMJ-Kondylenhaken, Dolwick	62
		TMJ-Raspel, Dolwick	63
		TMJ-Spreizer, Mod. Champy	65
		Transplantatstopfer	16
		Trokar, Tessier	102
		U	
		Unterkieferhaken, Hargis	70
		Unterkieferre retraktor, Terry	75
		Unterminierschere, Tessier	108

V

Vestibulumhaken	27
Vorderrandstripper, Hargis	70

W

Wangen-/Lippenhalter, Bishop	27
Wangen-Lippen-Haken, Arnett	120
Wangenhalter, Cawood-Minnesota	27
Wangenhalter, Martin-Simplex	27
Wangenhalter, Obwegeser, Draht	27
Wangenknochen-Haken, Arnett	120
Weichteilhaken, Tessier.....	104, 105, 106
Weichteilhaken	43, 81, 82
Weisheitszahn-Haken, Obwegeser.....	83
Wundhaken, Koberg.....	46

Z

Zungendrucker, Hartmann.....	28
Zungendrucker, Tobold	28
Zungendrucker, Wieder.....	28
Zungendrucker	21, 22
Zungenspatel, Brünings	29
Zungenspatel, Doyen	29
Zungenspatel, Doyen	29
Zungenspatel, Holz	29
Zungenspatel	23, 24, 25
Zungenzange, Collin.....	31
Zungenzange, Young.....	31
Zygoma-Ahle, Obwegeser.....	92
Zygoma-Elevatorium, Dingmann.....	57
Zygoma-Elevatorium, Gillies	57
Zygoma-Haken, Steinhäuser	79

- A**
Alveolar Nerv Dissector, Arnett119
Alveolar Retractor83
Anterior Border Stripper, Hargis70
Archbar, Erich53
Atraumatic Scalp Forceps, Tessier.....95
Atraumatic Muscle Forceps, Terry74
- B**
Blade Osteotome, Obwegeser.....88
Bone Contouring Forceps, flat94
Bone Cutting Forceps, Tessier.....101
Bone Expander, Marchac115
Bone Holding Forceps, Tessier101
Bone Holding Forceps, Steinhäuser.....59
Bone Hold. Forceps, Tessier.....101
Bone Holding Forceps, Jvs58
Bone Holding Forceps, Keen59
Bone Holding Forceps, Salyer60
Bone Holding Forceps, Wolford60
Bone Hook, Marchac115
Bone Hook, Tessier, Angled.....110
Bone Separator, Obwegeser90
Bone Shaping Forceps101
BSSO/LF1 Nerve Dissector, Arnett.....119
BSSO Condylar Seating Instrument, Arnett.....117
BSSO Lingual Retractor, Arnett.....116
BSSO Splitting Osteotome, Arnett122
BSSO Transoral Retractor, Arnett123
- C**
Calipers4
Caliper, Arnett123
Caliper, Marchac.....112
Caliper, Tessier110
Centre Drive® Blade, Dental Attachment128
Cross-Drive Blade, Dental Attachment.....128
Channel Retractor, Obwegeser44, 84
Channel Retractor, Steinhäuser.....76
Channel Retractor, Terry75
Cheek-Lip Retractor, Arnett120
Cheek/Lip Retractor, Bishop.....27
Cheek Bone Retractor, Arnett120
Cheek Retractor, Cawood-Minnesota.....27
Cheek Retractor, Martin-Simplex.....27
Cheek Retractor, Obwegeser27
Chest Support for Mouth Gag20
Chin Osteotomy Retractor, Arnett121
Chin Retractor, Obwegeser44, 84
Chisel, Steinhäuser78
Cleft Plate for Teethless.....21
Condylar Repositioner52
Contoured Forceps, concave/convex94
Contoured Forceps, convex/concave94
Coronoid Retractor, Arnett.....118
Coronoid Retractor, Hargis, with Chain72
Cross-Drive Bit, for ASD.....127
- E**
Elevator, Marchac111
Elevator, Obwegeser53, 86
Elevator, Steinberg, atraumatc113
Elevator, Steinberg.....112, 113
Elevator, Steinhäuser76
Elevator, Terry16
Elevator, Terry.....16
Endo-Condyle Unit11
Extraoral Retractor33
Extraoral Retractor, Eckelt.....32
Extraoral Retractor32
- F**
Finger Protector, Langenbeck18
Flat Nose Pliers, Obwegeser93
Forceps, Arnett.....118
Fragment Forceps, Obwegeser89
Fragment Forceps, Obwegeser89
Frame only21, 22, 23, 24
Front Template, Marchac, Adolescent112
Front Template, Marchac, Child112
- G**
Graft Packer, Terry16
- H**
Hook, Dingmann-Wilk, sharp58
- I**
Iliac Crest Retractor, Tessier.....100
Inner Progeny Retractor, Lauer47, 49, 50
Interdental Osteotome, Arnett121
Intraoral Retractor.....34, 35, 36
- J**
Jaboma Cleft Palate Set1-4
- L**
LF1 Interdental Osteotomy Retractor, Arnett.....121
LF1 Plate Bending Forceps, Arnett125
LF1 Posterior Retractor, Arnett118
LF1 Interdental Elevator, Arnett116
Lindemann, Burr17
Lindorf Drilling/Screwing Aid.....128
Lindorf Explantation Instrument.....127
Lindorf Ramus Claw Retractor40, 41
Lindorf Side Step Retractor.....40
Lindorf Side Step Retractor.....41
Lip and Cheek Retractor, Hargis69
Lip Retractor, Oringer.....26
Lip Retractor, Sternberg.....27
- M**
Mallet, Arnett122
Mandibular Retractor, Hargis70
Mandibular Awl, Obwegeser92
Mandibular Body Retractor, Arnett117
Maxillary Mobilizer91
Maxillary Mobilizer, Tessier.....57
Maxillary Sinus Curette, Arnett117
Mental Nerve Retractor120
Midline Flap Retractor, Arnett.....124
Mobilization Lever, Tessier111
Mouth Gag, Davis Boyle.....23
Mouth Gag, Denhart.....19
Mouth Gag, Dingmann25
Mouth Gag, Heister19
Mouth Gag, Jennings.....26
Mouth Gag, Kilner-Doughty20, 21
Mouth Gag, Mclvor.....24
Mouth Gag, Molt, for Adults19
Mouth Gag, Molt, for Children19
Mouth Gag, Neukam22
Mouth Gag, Roser-Koenig.....19
Mouth Gag, with Joint, Davis-Boyle.....23
Mouth Prop, McKesson, for Adults.....18
Mouth Prop, McKesson, for Children.....18
Mouth Prop, McKesson, for Infants.....18
Mouth Prop, McKesson, for Teehtless.....18
Mouth Wedge, Pitha.....18
- N**
Napkin Holder, Adams18
Nasal Awl, Tessier102
Nasal Mucosa Retractor, Arnett125
Nasal Speculum, Tessier96
- O**
Oral Screw, Maunder, Wood, conic18
Orbita Elevator80
Orbital Osteotome, Steinhäuser80
Orbital Retractor, Rowe54
Orbital Rim Retractor, Donovan54
Orbital Rim Retractor54
Osteotome, Bauer66
Osteotome, Dunn-Dautrey.....67
Osteotome, elastic91
Osteotome, Epker-Bauer.....66
Osteotome, Epker67, 68
Osteotome, Marchac.....115
Osteotome, Munro-Dautrey66, 67
Osteotome, Obwegeser91
Osteotome, Tessier107
Osteotome, Tessier.....97, 98
Osteotome, Wolford.....80
Outer Progeny Retractor, Lauer47, 49, 50
- P**
Palatal Expander, Turvey76
Palatal Osteotome107
Perforator, Tessier.....102
Periosteal Elevator, Arnett124
Periosteal Elevator, Arnett124
Periosteal Elevator52
Periosteal Elevator52
Piriform Rim Retractor, Hargis.....72
Plate Bending Forceps, Arnett, short124
Plate Carrier, Arnett125
Plate Holding Instrument, Eckelt58
Progeny Retractor, Metz45
Progeny Retractor, Schuchardt45
Pterygoid Osteotome, Hargis72
Pterygoid Osteotome, Arnett122
- R**
Ramus Elevator, Arnett.....116
Ramus Forceps, Obwegeser84
Ramus Forceps, Steinhäuser.....77
Ramus Osteotome, Steinhäuser78, 78
Ramus Stripper, Terry.....75
Ramus Raspatory, Obwegeser87
Ramus Retractor, Hargis69
Ramus Retractor, Obwegeser44, 83
Ramus Separator, Smith.....73
Ramus Set, Steinberg.....113
Ramus Stripper, Obwegeser86
Raspatory48
Raspatory, deep v-shape52
Raspatory, Obwegeser, v-shape.....52
Raspatory, Obwegeser51, 85, 86
Raspatory, Tessier.....102
Reposition Forceps, Adult,109
Reposition Forceps, Child,109
Reposition Forceps, Rowe56
Reposition Forceps, Steinhäuser78
Retractor, Ishi38, 39
Retractor, Koberg.....46
Retractor, Obwegeser.....81, 82
Retractor, Shea37
Retractor, Wolford80
Retractor for BSSO Incision Closure, Arnett.....119
Rubber Inserts, Pair31
- S**
Separator, Smith73
Septum Elevator, Arnett119
Septum Osteotome, Obwegeser87
Septum Osteotome, Terry.....75
Septum Osteotome, Tessier.....107
Skin Hook, Tessier.....95
Soft Tissue Retractor, Tessier104, 105, 106
Soft Tissue Retractor43
Spatula, Tessier, malleable.....103
Spatula, Tessier103
Spina Nasalis Retractor, Obwegeser43
Spina Nasalis Retractor, Obwegeser83
Spreading Forceps, Tessier110
Stripper, Hargis.....71
Stripper, Hargis.....71
Stripper, Hargis.....71
Stripper, Hargis.....71
Stripper, Obwegeser86
Stripper, Obwegeser86
Suction Dissector, Marchac.....115
- T**
TC-Scissors, Tessier108
TC-Wire Twisting Forceps, Obwegeser93
TC-Wire Twisting Forceps, wide93
Thoracic Retractor, Tessier99
Thorax Retractor, Tessier99
Ti-Lindemann, Burr17
Ti-Lindemann, Burr17
Ti-Lindemann, Burr17
TMJ Condyle Retractor, Dolwick62
TMJ Disc Forceps, Dolwick62
TMJ Disc Scissors, Dolwick62
TMJ Elevator, Dolwick62
TMJ Forceps, Dolwick64
TMJ Rasp, Dolwick,63
TMJ Rasp, Dolwick, hollow63

TMJ Spreader, Champy-Type	65
TMK Forceps, Dolwick.....	64
Tongue Depressor, Bruenings	29
Tongue Depressor, Bruenings	31
Tongue Depressor, Doyen	29
Tongue Depressor, Doyen	29
Tongue Depressor, Hartmann.....	28
Tongue Depressor, Plastic	29
Tongue Depressor, Tobold.....	28
Tongue Depressor, Wieder	28
Tongue Depressor, Wood	29
Tongue Depressor	21, 22, 23, 24, 25
Tongue Holding Forceps, Young	31
Trocar, Tessier,	102

U

Undermining Scissors, Tessier.....	108
Upper Lip Retractor, Arnett	120

V

Vestibulum Retractor	27
----------------------------	----

W

Wedge Osteotome, Obwegeser	88
Wire Cutter, Tessier	108
Wire Introducer, Terry	75
Wire Nipper, Obwegeser	93
Wire Pusher, double-ended	53
Wire Pusher, Rowe	53

Z

ZMJ Rasp, Dolwick, flat	63
Zygoma Elevator, Dingmann.....	57
Zygoma Elevator, Gillies.....	57
Zygoma Retractor, Steinhäuser	79
Zygoma Retractor, Steinhäuser	79
Zygomatic Awl, Obwegeser.....	92

A			
Adams, Porta-servilleta	18		
Arnett, Calibre	123		
Arnett Martillo	122		
Asc. Ramus Elevador, Arnett	116		
At-Terry, Pinza Muscular, derecha	74		
At-Terry, Pinza Muscular, izquierda	74		
B			
Bajalengua	21, 22, 25		
Bastidor solo	24		
Bastidor suelto	21, 22		
Bastidor suelto solo	23		
Bauer, Osteótomo, recto	66		
Bauer, Osteótomo	66		
Bishop, Separador para Labios y Mejilla	27		
Bocas de Goma, Par	31		
Bruenings, Espátula Lingual, Fenest	29		
C			
Cawood-Minnesota, Separador, fenestrado	27		
Cawood-Minnesota, Separador	27		
Champy, Separador para Atm	65		
Cheek Bone Retractor, Arnett	120		
Chin Osteotomy Retractor, Arnett	121		
Collin, Pinza Tira-Lengua, fenest	31		
Compases	4		
Coronoid Retractor, Arnett	118		
Centre Drive® Punta	127		
Cross-Drive Punta	127		
D			
Dautrey-Munro, Osteótomo	66		
Davis-Boyle, Abrebocas	23		
Davis-Boyle Bajalengua	23		
Denhart, Abrebocas	19		
Dingmann, Elevador Cigomático	57		
Dingmann-Wilk, Gancho, agudo	58		
Dingmann Abreboca completo	25		
Disecador para nervio alveolar OSB	119		
Dolwick, Disecador, curvo fuerte	63		
Dolwick, Disecador, hueco	63		
Dolwick, Disecador, plana	63		
Dolwick, Elevador Atm	62		
Dolwick, Gancho para Condilo Atm	62		
Dolwick, Pinza Atm, grande	64		
Dolwick, Pinza Atm, pequeña	64		
Dolwick, Pinza Atm	62		
Dolwick, Tijera Atm	62		
Donovan, Separador Borde Orbital	54		
Doyen, Bajalengua	29		
Dunn-Dautrey, Osteótomo	67		
E			
Eckelt, Gancho para sujetar Placas	58		
Eckelt, Separador extraoral	32, 33		
Empujador de Alambre, doble	53		
Endo-Condyle Unit	11		
Epker, Osteótomo	67, 68		
Epker-Bauer, Osteótomo	66		
Erich, Arco de Alambre, Metro	53		
Espátula Lingual, Madera	29		
Espátula Lingual, Plástico	29		
F			
Forceps, Arnett	118		
G			
Gillies, Elevador Cigomático, angul.	57		
H			
Hargis, Eucleador	71		
Hargis, Gancho Mandibular	70		
Hargis, Gancho para Ramo, derecha	69		
Hargis, Gancho para Ramo, izquierda	69		
Hargis, Gancho Piriforme	72		
Hargis, Osteótomo Pterigoideo	72		
Hargis, Pinza para Coger, C/Cadena	72		
Hargis, Separador Borde Anterior	70		
Hargis, Separador para Mejillas	69		
Hartmann, Bajalengua	28		
Heister, Abreboca	19		
I			
Instrumento para Reponer Condilos	52		
J			
Jaboma Instrumental para operaciones del paladar	1-4		
Jennings, Abreboca	26		
Jvs Pinza para Huesos, fuerte	58		
Jvs Pinza para Huesos, ligera	58		
K			
Keen, Pinza para Huesos	59		
Keen, Pinza para Huesos	59		
Kilner-Doughty, Abreboca	20, 21		
Koberg, Separador	46		
Koberg, Separador	46		
L			
Langenbeck, Dedal	18		
Lauer, Separador Mandibular	47		
Lauer, Separador Mandibular	47		
Lauer, Separador Mandibular	49		
Lauer, Separador Mandibular	50		
Lauer, Separador Mandibular	50		
Legra, Punta De Trabajo	48		
Legra	48		
LF1 Alicata para doblar Placas, Arnett	125		
LF1 Osteótomo interdental, Arnett	121		
LF1 Retractor interdental, Arnett	116		
LF1 Retractor posterior, Arnett	118		
Lindemann, Fresa	17		
Lindorf, Ayuda para Perforar/Atornillar	128		
Lindorf, Instrumento para Explantación	127		
Lindorf, Separador Garra Rama	40, 41		
Lindorf, Separador Side Step	40, 41		
M			
Marchac, Calibre	112		
Marchac, Disecador, recto	115		
Marchac, Osteótomo	115		
Marchac, Periostótomo	111		
Marchac, Pinza para Separar Huesos	115		
Marchac, Plantilla Frontal, Adultos	112		
Marchac, Plantilla Frontal, Niños	112		
Marchac Ganchito, agudo	115		
Martin-Simplex, Separador de Mejilla	27		
Maunder, Cuna Abreboca, Madera	18		
Mclvor, Abreboca completo	24		
Mclvor Bajalengua	24		
McKesson, Garrote, para Adultos	18		
McKesson, Garrote, para Adultos	18		
McKesson, Garrote, para Bebes	18		
McKesson, Garrote, para Desdentados	18		
McKesson, Garrote, para Niños	18		
Metz, Separador Mandibular	45		
Molt, Abre-Boca, para Ninos	19		
Molt, Abreboca, para Adultos	19		
N			
Neukam Abreboca Completo	22		
O			
Obwegeser, Alicates	93		
Obwegeser, Elevador, doble	53		
Obwegeser, Elevador	86		
Obwegeser, Gancho de Menton	44, 84		
Obwegeser, Legra, redonda	85		
Obwegeser, Legra	85		
Obwegeser, Lezna Cigomática	92		
Obwegeser, Lezna Mandibular	92		
Obwegeser, Movilizador Maxilar	91		
Obwegeser, Osteótomo, Flex	91		
Obwegeser, Osteótomo	91		
Obwegeser, Periostótomo	51, 52, 86, 87, 88		
Obwegeser, Pinza p. Fragmentos, derecha	89		
Obwegeser, Pinza p. Fragmentos, izquierda	89		
Obwegeser, Pinza Ramo, largo, derecha	84		
Obwegeser, Pinza Ramo, largo, izquierda	84		
Obwegeser, Pinza Ramo, pequeña, derecha	84		
Obwegeser, Pinza Ramo, pequeña, izquierda	84		
Obwegeser, Retractor Mandib	84		
Obwegeser, Separador	43, 81, 82, 83		
Obwegeser, Separador Alveolar	83		
Obwegeser, Separador De Mejilla, Alambre	27		
Obwegeser, Separador Mandibular	44		
Obwegeser, Separador para Ramo	44		
Obwegeser, Separador Spina Nasalis	43, 83		
Oringer, Separador para Labios, Juego	26		
Oringer, Separador para Labios	26		
Osteótomo de Paladar	107		
Osteótomo interdental, Arnett	121		
Osteótomo pterigoideo, Arnett	121		
P			
Periostótomo, fuertemente	52		
Periostótomo, ligeramente	52		
Periostótomo	52		
Pinza para Formar Huesos, concavo/convexo	94		
Pinza para Formar Huesos, convexo/concavo	94		
Pinza para Formar Huesos, plana	94		
Pitha, Garrote, con Cadena	18		
R			
Retractor para mejillas y labios, Arnett	120		
Retractor para Labio superior, Arnett	120		
Roser-König, Abreboca	19		
Rowe, Empujador de Alambre	53		
Rowe, Gancho Orbital, derecho	54		
Rowe, Gancho Orbital, izquierdo	54		
Rowe, Pinza Reposición, derecha	56		
Rowe, Pinza Reposición, izquierda	56		
S			
Salyer, Pinza para Huesos	60		
Schuchardt, Separador Mandibular	45		
Separador Extraoral	32, 33, 34, 35, 36		
Separador Intraoral, Ishi	38, 39		
Separador Mandíbula, Lauer	49		
Separador para Borde Orbital	54		
Separador para Hueso, Obwegeser	90		
Separador para Vestíbulo	27		
Septum Elevator, Arnett	119		
Shea, Sepador	37		
Smith, Gancho Mobilizador, derecho	73		
Smith, Gancho Mobilizador, izquierda	73		
Smith, Separador De Ramo	73		
Soporte de Paladar	21		
Steinberg, Periostótomo	112, 113		
Steinberg, Separador Ramo	113		
Steinhäuser, Pinza para Huesos	59		
Steinhäuser, Cincel	78		
Steinhäuser, Elevador	76		
Steinhäuser, Elevador Orbital	80		
Steinhäuser, Gancho Mandibular	76		
Steinhäuser, Instrumento de Reposición	78		
Steinhäuser, Osteótomo	78		
Steinhäuser, Osteótomo Orbital	80		
Steinhäuser, Osteótomo Orbital	80		
Steinhäuser, Pinza para Ramo, derecha	77		
Steinhäuser, Pinza para Ramo, izquierda	77		
Steinhäuser, Separador Cigoma, derecha	79		
Steinhäuser, Separador Cigoma, izquierda	79		
Sternberg, Separador para Labios	27		
T			
TC-Obwegeser, Pinza Torce-Hilos	93		
TC-Tessier, Tijera, aguda, recta	108		
TC-Tessier, Tijera, roma, recta	108		
Terry, Corredera De Rama	75		
Terry, Elevador	16		
Terry, Elevador	16		
Terry, Elevador	16		
Terry, Gancho Mandibular	75		
Terry, Introductor De Alambre	75		
Terry, Osteótomo para Septum	75		
Tessier, Calibre, angulado	110		
Tessier, Cizalla para Huesos	101		
Tessier, Cizalla para Huesos	101		
Tessier, Erina, aguda	95		
Tessier, Espátula Maleable	103		
Tessier, Espéculo Nasal	96		
Tessier, Gancho Cresta Iliaca	100		
Tessier, Gancho Cresta Iliaca	100		
Tessier, Gancho De Movilizacion, derecha	111		

Tessier, Gancho De Movilizacion, izquierda111
 Tessier, Gancho Movilizacion, Derecho.....57
 Tessier, Gancho Movilizacion, izquierdo.....57
 Tessier, Gancho para Huesos, angul.....110
 Tessier, Gancho Tórax.....99
 Tessier, Legra102
 Tessier, Legra102
 Tessier, Lezna Nasal102
 Tessier, Osteótomo, recto.....97, 98
 Tessier, Osteótomo.....97, 98, 107
 Tessier, Osteótomo Nasal, recto107
 Tessier, Periostótomo.....102
 Tessier, Periostótomo.....102
 Tessier, Pinza de Expansión,110
 Tessier, Pinza para Cabelludo.....95
 Tessier, Pinza para Formar Huesos.....101
 Tessier, Pinza para Huesos.....101
 Tessier, Pinza para Huesos.....101
 Tessier, Pinza Reposición, derecha, Adultos109
 Tessier, Pinza Reposición, derecha, Niños.....109
 Tessier, Pinza Reposición, izquierdo, Adultos ...109
 Tessier, Pinza Reposición, izquierdo, Niños109
 Tessier, Punzón.....102
 Tessier, Separador104, 105, 106
 Tessier, Tijera de Disecc.....108
 Tessier, Tijera para Alambre, recta108
 Tessier, Trocar102
 Ti-Lindemann, Fresa17
 Ti-Lindemann, Fresa17
 Ti-Lindemann, Fresa17
 Tobold, Bajalengua28
 Tobold, Bajalengua28
 Turvey, Extensor Palatinal76

U

Unité endo-condylienne127

W

Wieder, Bajalengua28
 Wolford, Osteótomo, angulado.....80
 Wolford, Pinza para Huesos.....60

Y

Young, Pinza Tira-Lengua, acodada.....31

A			
Abaisse-Langue pour Ouvre-Bouche, Neukam.....	22		
Abaille-Langue	21, 29		
Abaisse-Langues en Bois.....	29		
Adams, Porte-Serviettes.....	18		
Adapt. Emb. Dent.....	128		
Appui-Poitrine pour Ouvre-Bouche	20		
B			
Bauer, Ostéotome	66		
Bishop, Ecarteur Lèvres/Joues.....	27		
Bruenings, Abaisse-Langue.....	29		
BSSO/LF1 Dissecteur de Nerf, Arnett.....	119		
BSSO Instrument de Positionnement, Arnett.....	117		
BSSO Ostéotome Dédoublément, Arnett.....	122		
BSSO Rétracteur Lingual, Arnett.....	116		
BSSO Rétracteur Transoral, Arnett	123		
C			
Calibre Arnett.....	123		
Cawood-Minnesota, Ecarteur	27		
Champy, TMJ Rétracteur.....	65		
Compas	4		
Collin, Pince Tire-Langue.....	31		
Centre Drive Lames pour Vis	127		
Centre Drive Lames pour Vis.....	127		
Cross-Drive Lames pour Vis	127		
Curette p. Sinus Maxillaire, Arnett.....	117		
D			
Dautrey-Munro, Ostéotome	66		
Davis-Boyle, Abaisse-Langue.....	23		
Davis-Boyle, Manche seul	23		
Davis-Boyle, Ouvre-Bouche Jeu.....	23		
Denhart, Ouvre-Bouche	19		
Dingman, Abaisse-Langue	25		
Dingman, Elévateur Zygomatique.....	57		
Dingman-Wilk, Ecarteur	58		
Dolwick, Crochet	62		
Dolwick, TMJ Ciseaux.....	62		
Dolwick, TMJ Elévateur	62		
Dolwick, TMJ Pince	62, 64		
Dolwick, TMJ Rugine-Rasp	63		
Doyen, Abaisse-Langue.....	29		
Dunn-Dautrey, Ostéotome	67		
E			
Ecarteur à Joue Fenêtre	27		
Ecarteur à Progenie	44		
Ecarteur à Os d'Obwegeser	90		
Ecarteur de Joue d'Obwegeser	27		
Ecarteur des Lèvres et Jones, Arnett.....	120		
Ecarteur d'Obwegeser.....	43		
Ecarteur pour le Ramus.....	44		
Ecarteur pour Vestibulum	27		
Eckelt, Crochet pour Maintenir Plaque.....	58		
Eckelt, Rétracteur Extra-Oraux	32		
Eckelt, Rétracteur Extra-Oraux Lum. Froide	33		
Elévateur à Périoste, Arnett	124		
Elévateur-Dissec. d'Obwegeser	53		
Elévateur pour le Perioste, Fort Courbé	52		
Elévateur pour le Perioste, Leger. Courbé.....	52		
Epker, Ostéotome	67, 68		
Epker-Bauer, Ostéotome	66		
Erich, Arc De Fil (par Mètre)	53		
Ecarteur à Progenie.....	44		
Ecarteur pour Spina Nasalis	43		
Endo-Condyle Unit	11		
H			
Hargis, Crochet p. la Fosse Piriforme	72		
Hargis, Ecarteur Machoire Inf.....	70		
Hargis, Ecarteur pour le Bord Antérieur	70		
Hargis, Ecarteur pour Lèvres et Joues	69		
Hargis, Rugine-Raspatoires.....	71		
Hargis, Ptérygoïde Ostéotome	72		
Hargis, Ramus Ecarteur	69		
Hargis, Stripper	71		
Hartmann, Abaisse-Langue.....	28		
Heister, Ouvre-Bouche.....	19		
I			
Interdental Ostéotome, Arnett	121		
J			
Jaboma, set d'instruments pour fente.....	1-4		
Jennings, Ouvre-Bouche	26		
Jvs Daviers, Porte-Os.....	58		
K			
Keen Daviers Porte-Os.....	59		
Kilner-Doughty, Ouvre-Bouche	20, 21		
Koberg Ecarteurs	46		
L			
Langenbeck, Doigtier	18		
Lauer, Crochet de Progenie, Ext.....	47, 49, 50		
Lauer, Crochet de Progenie, Int.....	47, 49, 50		
LF1 Rétracteur Interdentaire, Arnett.....	121		
LF1 Rétracteur Postérieur, Arnett	118		
LF1 Pince de Pliage, Arnett	125		
Lindorf, Aide De Forage/Vissage	128		
Lindorf, Instrument D'Explantation	127		
Lindorf, Rétracteur	40, 41		
M			
Manche pour Ouvre-Bouche, Neukam.....	22		
Marchac, Calibre.....	112		
Marchac, Elévateur	111		
Marchac, Gabarit Frontal p. Adultes et Bébés	112		
Marchac, Irrigateur	115		
Marchac, Ostéotome	115		
Marchac, Pince pour Separer OS.....	115		
Maillet, Arnett	122		
Maunder, Bâillon.....	18		
Mclvor, Abaisse-Langue.....	24		
Mclvor, Manche à Ouvre-Bouche	24		
Mclvor, Ouvre-Bouche Jeu Cpl	24		
McKesson, Ouvre-Bouche	18		
Mèche, Lindemann	17		
Metz, Chrochets de Progenie.....	45		
Mobilisateur de Tessier gaucheche.....	57		
Mobilisateur Obwegeser pour Maxillaire.....	91		
Molt, Ouvre-Bouche Adultes.....	19		
Molt, Ouvre-Bouche, Enfants.....	19		
Mors, Caoutchouc, Young	31		
N			
Neukam, Ouvre-Bouche, Complet	22		
O			
Obwegeser, Alène	92		
Obwegeser, Channel Retractor	84		
Obwegeser, Contouring Forceps.....	94		
Obwegeser, Ecarteur	81, 82		
Obwegeser, Ecarteur Dent Sagesse	83		
Obwegeser, Ecarteur Mandibulaire.....	84		
Obwegeser, Ecarteur Porte-Menton	84		
Obwegeser, Ecarteur Spina Nasalis	83		
Obwegeser, Elévateur.....	85, 86		
Obwegeser, Ostéotome	88, 91		
Obwegeser, Ostéotome p. Cloison Nasale	87		
Obwegeser, Pince à Couper le Fil.....	93		
Obwegeser, Pince p. Former OS	94		
Obwegeser, Pince à Modeler	94		
Obwegeser, Pince à Torsader	93		
Obwegeser, Ecarteur p. Ramus	83		
Obwegeser, Pincas p. Ramus	84		
Obwegeser, Septum Ostéotome	87		
Obwegeser, Septum Ostéotome	87		
Oringer, Ecart. des Lèvres	26		
Ostéotome Palatinal	107		
Ostéotome Ptérygoïde, Arnett	122		
Outil De Positionnement	53		
Ouvre-Bouche avec Articulat. Davis-Boyle	23		
Ouvre-Bouche seul.....	21		
Ouvre Bouche Dingmann complet	25		
P			
Pince à Fragments D'Obwegeser.....	89		
Pince de Reposition, Rowe	56		
Pince de Maintien, Arnett	125		
Pincas, Arnett	118		
Pitha, Bâillon à Chaîne	18		
Plaque Palatine.....	21		
R			
Repositionneur pour Articul. Mahoire	52		
Rétracteur.....	32, 33		
Rétracteur Coronioïde, Arnett.....	118		
Rétracteur BSSO p. Fermet. d'Inces, Arnett.....	119		
Rétracteur pour Génioplastie, Arnett	121, 124		
Rétracteur pour Mandible, Arnett	117		
Rétracteur, Ishi	38, 39		
Rétracteur Intra-Oral	3, 35		
Rétracteur Intra Oral L&M A.L.F.....	36		
Rétracteur Shea	37		
Roser-Koen, Ouvre-Bouche	19		
Rowe, Orbit Retractor	54		
Rowe, Outil de Positionnement	53		
Rugine de Obwegeser	51		
Rugine D'Obwegeser	52		
Rugines-Raspatoires	48		
S			
Salyer, Daviers Porte-Os	60		
Schuchardt, Crochets de Progenie	45		
Steinhäuser, Ecarteur Cygomatique.....	79		
Simplex, Ecarteur Joues	27		
Smith, Ecarteur	73		
Smith, Ecarteur	73		
Smith, Pincas à Saisir	73		
Steinhäuser, Ciseaux-Burins.....	78		
Steinberg, Ecarteur Ped. Ramus	113		
Steinberg, Elévateur	112, 113		
Steinhäuser, Elévateur	76		
Steinhäuser, Daviers Porte-Os	59		
Steinhäuser, Orbital Elévateur	80		
Steinhäuser, Orbital Ostéotome.....	80		
Steinhäuser, Ostéotome	78		
Steinhäuser, Pince de Rép.	78		
Sternberg, Ecarteur Lèvres.....	27		
Support-Menton D'Obwegeser	44		
T			
Terry, Modif. Ostéotome	75		
Terry, Elévateur.....	16		
Terry, Introduteur p. Fil.....	75		
Terry, Manipulateur p. Ramus	75		
Terry, Pince-Clamp Musculaire.....	74		
Terry, Poussoirs p. Transplant.....	16		
Tessier, Ecarteur p. Parties Molles	106		
Terry, Rétracteur.....	75		
Tessier, Alène Nasale	102		
Tessier, Calibre	110		
Tessier, Ciseaux à Dissection.....	108		
Tessier, Ciseaux pour Fils	108		
Tessier, Ciseaux TC	108		
Tessier, Ecarteur p. Parties Molles	101		
Tessier, Ecarteur.....	110, 111		
Tessier, Ecarteur Chirurgie Thoracique	99		
Tessier, Ecarteur p. Parties Molles	106		
Tessier, Elévateur.....	102		
Tessier, Grignes Cutanées	95		
Tessier, Iliac Crest Rétracteur.....	100		
Tessier, Mod. Kawamoto, Ostéotome.....	107		
Tessier, Ostéotome.....	97, 98		
Tessier, Ostéotome Nasal.....	107		
Tessier, Perforateur.....	102		
Tessier, Periosteal Elévateur	102		
Tessier, Pince pour Cuir Chevelu	95		
Tessier, Pincas Coupantes Os.....	101		
Tessier, Pincas Coupantes Os.....	101		
Tessier, Rétracteur Malléable.....	103		
Tessier, Rétracteur Parties Molles.....	104, 105		
Tessier, Speculum Nasal	96		
Tessier, Trocarts	102		
Tessier-Rowe, Pince à Reduc, droit,	109		
Tessier-Rowe, Pince à Reduc., gauche	109		
Tessier Daviers, Porte-Os	101		
Ti-Lindemann, Mèches.....	17		
Tobold, Abaisse-Langue.....	28		
Turvey, Palatum Ecarteur	76		
W			
Wieder, Abaisse-Langue.....	28		
Wieder, Abaisse-Langue.....	28		
Wolford, Daviers Porte-Os.....	60		
Wolford, Ostéotome.....	80		
Y			
Young, Pince Tire-Langue.....	31		

A			
Abbassalingua, Davis-Boyle.....	23		
Abbassalingua, Dingmann.....	25		
Abbassalingua, Hartmann.....	28		
Abbassalingua, Kilner-Doughty.....	21		
Abbassalingua, Mclvor.....	24		
Abbassalingua, Neukam.....	22		
Abbassalingua, Tobold.....	28		
Abbassalingua, Wieder.....	28		
Abbassalingua Bruenings.....	29		
Abbassalingua di Legno.....	29		
Abbassalingua Doyen.....	29		
Abbassalingua Plast.....	29		
Alesatore, Lindemann.....	17		
Apribocca, Denhart.....	19		
Apribocca, Dingmann, completo.....	25		
Apribocca, Heister.....	19		
Apribocca, Jennings.....	26		
Apribocca, Maunder.....	18		
Apribocca, McKesson.....	18		
Apribocca, Molt, per Adulti.....	19		
Apribocca, Molt, per Bambini.....	19		
Apribocca, Pitha.....	18		
Apribocca, Roser-Koenig.....	19		
Arco di Filo, Erich.....	53		
Arnett, Calibro.....	123		
Arnett, Curretta.....	116		
Arnett, Curretta Seno Mascel. Anter.....	117		
Arnett, Dissettore Nervo Alveolare.....	119		
Arnett, Dissettore Nervo Inf. BSSO.....	121		
Arnett, Dissettore Nervo Inferiore.....	119		
Arnett, Elevatore Periost.....	124		
Arnett, Elevatore Per Setto Nasale.....	119		
Arnett, Elevatore Ramo Ascendente.....	116		
Arnett, Martello.....	122		
Arnett, Osteotomo BSSO.....	122		
Arnett, Osteotomo Interdentale.....	121		
Arnett, Osteotomo Pterigoideo.....	122		
Arnett, Pinza, Morso.....	118		
Arnett, Pinza Piegaplacche.....	125		
Arnett, Pinza Piegaplacche corta.....	124		
Arnett, Pinza Portaplacche.....	125		
Arnett, Retrattore Coronoido.....	118		
Arnett, Retrattore Lembo Mediano.....	124		
Arnett, Retrattore Linguale.....	116		
Arnett, Retrattore Mandibolare.....	117		
Arnett, Retrattore Mucosa Nasale.....	125		
Arnett, Retrattore Osteot. Sinfisi Mandib.....	121		
Arnett, Retrattore Per Guancia.....	120		
Arnett, Retrattore Post. Le Fort.....	118		
Arnett, Retrattore Transorale BSSO.....	123		
Arnett, Strum. per Condilo Mandibolare.....	117		
C			
Calibro, Marchac.....	112		
Calibro, Tessier.....	110		
Compassi.....	4		
D			
Dissettore ad Aspirazione, Marchac.....	115		
Divaricatore, Cawood-Minnesota.....	27		
Divaricatore, Cawood-Minnesota Fenest.....	27		
Divaricatore, Champy.....	65		
Divaricatore, Donovan.....	54		
Divaricatore, Koberg.....	46		
Divaricatore, Obwegeser.....	81, 82, 83		
Divaricatore, Rowe.....	54		
Divaricatore, Steinberg.....	113		
Divaricatore, Steinhäuser.....	76		
Divaricatore, Sternberg.....	27		
Divaricatore, Tessier.....	104, 105, 106		
Divaricatore Hargis per Mandibola.....	70		
Divaricatore Orbitale.....	54		
Divaricatore per Condilo, Dolwick.....	62		
Divaricatore per Cresta Iliaca, Tessier.....	100		
Divaricatore per Guancia, Martin-Simplex.....	27		
Divaricatore per Labbra, Oringer.....	26		
Divaricatore per Labbra e Guancia, Bishop.....	27		
Divaricatore per Ramo, Hargis.....	69		
Divaricatore per Zigomo, Steinhäuser.....	79		
Divaricatore Toracico, Tessier.....	99		
Divaricatore Toracico, Tessier.....	99		
Divaricatore Zigomo, Dingman-Wilk.....	58		
E			
Elevatore Periost., Tessier.....	102		
Elevatore, Dolwick.....	62		
Elevatore, Hargis.....	71, 72		
Elevatore, Steinberg.....	113		
Elevatore, Steinhäuser.....	76		
Elevatore, Terry.....	16		
Elevatore, Terry Packer.....	16		
Elevatore Doppio, Obwegeser.....	53		
Elevatore Doppio, Steinberg.....	112		
Elevatore Krenkel Leggermente.....	52		
Elevatore per Periostio.....	48		
Elevatore per Ramo, Obwegeser.....	87		
Elevatore Steinhäuser.....	80		
Elevatore Zigomo, Dingman.....	57		
Elevatore Zigomo, Gillies.....	57		
F			
Forbice, Dolwick.....	62		
Forbice, Tessier.....	108		
Forbice per Tunnelare, Tessier.....	108		
Forbici TC, Tessier.....	108		
Forbici TC, Tessier.....	108		
G			
Gancio, Tessier.....	57		
Gancio, Tessier.....	57		
Gancio per Cute, Tessier.....	95		
Gancio per Ossa, Tessier.....	110		
I			
Introduttore per Filo, Terry.....	75		
J			
Jaboma, set di strumenti per cheilo-labbro.....	1-4		
L			
Leva, Tessier.....	111		
Leva, Tessier.....	111		
Lindorf, Aiuto per Perforare/Avviare.....	128		
Lindorf, Divaricatore.....	40, 41		
Lindorf, Strumento per Espiantazione.....	127		
M			
Mobilizzat per Mascella, Obwegeser.....	91		
O			
Osteotomo, Bauer.....	66		
Osteotomo, Dautrey-Munro.....	66		
Osteotomo, Dunn-Dautrey.....	67		
Osteotomo, Epker-Bauer.....	66		
Osteotomo, Epker.....	67, 68		
Osteotomo, Hargis.....	72		
Osteotomo, Marchac.....	115		
Osteotomo, Obwegeser.....	88, 91		
Osteotomo, Steinhäuser.....	78		
Osteotomo, Terry.....	75		
Osteotomo, Tessier.....	97, 98, 107		
Osteotomo Nasale, Obwegeser.....	87		
Osteotomo Palatale.....	107		
Osteotomo per Setto Nasale, Tessier.....	107		
Osteotomo Steinhäuser.....	80		
Osteotomo Steinhäuser per Ramo.....	78		
Osteotomo Wolford.....	80		
P			
Paio Cuscino di Gomma per Pinza Young.....	31		
Perfor., Tessier.....	102		
Periostotomo, Obwegeser.....	51, 52		
Periostotomo, Marchac.....	111		
Periostotomo, Obwegeser.....	85, 86		
Periostotomo Doppio, Obwegeser.....	86		
Pinza, Dolwick.....	62		
Pinza, Rowe.....	56		
Pinza con Catena, Hargis.....	72		
Pinza Jeter-Van Sickels.....	58		
Pinza Obwegeser Piatta.....	93		
Pinza Obwegeser Piatta Punta Retta.....	93		
Pinza per Afferrare Ossa, Obwegeser.....	94		
Pinza per Afferrare Ossa, Keen.....	59		
Pinza Per Allargare, Marchac.....	115		
Pinza per Allargare, Tessier.....	110		
Pinza per Cuio Capelluto, Tessier.....	95		
Pinza per Formare Ossa, Tessier.....	101		
Pinza per Frammenti, Obwegeser.....	89		
Pinza per Muscolo, Terry.....	74		
Pinza per Ossa, Salyer.....	60		
Pinza per Ossa, Steinhäuser.....	59		
Pinza per Ossa, Tessier.....	101		
Pinza per Ossa, Wolford.....	60		
Pinza per Ramo, Obwegeser.....	84		
Pinza per Ramo, Smith.....	73		
Pinza per Ramo, Steinhäuser, destra.....	77		
Pinza per Ramo, Steinhäuser, sinistra.....	77		
Pinza per Riduz., Tessier.....	109		
Pinza Tagliaossa, Tessier.....	101		
Pinza TC, Obwegeser, Punta Grossa.....	93		
Pinza TC, Obwegeser.....	93		
Pinza Tiralingua Collin.....	31		
Pinza Tiralingua Young.....	31		
Placca per Palato.....	21		
Portatovaglioli, Adams.....	18		
Posizionatore, Terry.....	75		
Posizionatore per Filo, Rowe.....	53		
Posizionatore per Filo.....	53		
Proteggidito, Langenbeck.....	18		
Punta Centre Drive®.....	127		
Punta Cross Drive.....	127		
Punteruolo per Mandibola, Obwegeser.....	92		
Punteruolo per Zigomo, Obwegeser.....	92		
Punteruolo Tessier Transnasale.....	102		
R			
Raspa, Dolwick.....	63, 64		
Retrat. Tessier Mail.....	103		
Retrattore, Obwegeser.....	84		
Retrattore, Obwegeser.....	84		
Retrattore, Terry.....	75		
Retrattore Guancia, Obwegeser.....	27		
Retrattore Intraorale.....	34		
Retrattore Intraorale.....	34		
Retrattore Labbro Superiore.....	120		
Retrattore Nervo Sinfisi Mandibolare.....	120		
Retrattore Ishi.....	38, 39		
S			
Sagoma Frontale Marchac Bambini/Adulti.....	112		
Sagoma Frontale Marchac per Neonati.....	112		
Separatore, Hargis.....	69		
Separatore, Obwegeser.....	43, 83, 84		
Separatore, Schuchardt-Lauer.....	50		
Separatore, Turvey.....	76		
Separatore Extraorale, Eckelt.....	32, 33		
Separatore Extraorale.....	32, 33		
Separatore Hargis per Bordo Anteriore.....	70		
Separatore Intraorale.....	35		
Separatore Intraorale L&M.....	36		
Separatore Lauer per Progenismo.....	47, 49		
Separatore per Mento, Obwegeser.....	44		
Separatore per Ossa, Obwegeser.....	90		
Separatore per Progenismo, Metz.....	45		
Separatore per Progenismo, Schuchardt.....	45		
Separatore per Vestibulo.....	27		
Separatore Sagittale, Smith.....	73		
Separatore Shea con Luce Fredda.....	37		
Set Apribocca, Davis-Boyle.....	23		
Set Apribocca, Kilner-Doughty.....	20, 21		
Set Apribocca, Mclvor.....	24		
Set Apribocca, Neukam.....	22		
Set di 3 div., Oringer.....	26		
Specolo Nasale, Tessier.....	96		
Strum. Di Riposizion. Condilare.....	52		
Strum. per Riduzione, Steinhäuser.....	78		
Strumento Per Riposiz. Placche, Eckelt.....	58		
Supporto Contro-Petto per Apribocca.....	20		
T			
Telaio Apribocca, Davis-Boyle.....	23		
Telaio Apribocca, Davis-Boyle.....	23		
Telaio Apribocca, Kilner-Doughty.....	21		
Telaio Apribocca, Mclvor.....	24		
Telaio per Apribocca.....	22		
Trequarti, Tessier.....	102		
Tronchesino, Obwegeser.....	93		
Turat. Terry.....	16		
U			
Uncino per Ossa, Marchac.....	115		

KLS Martin Group

KLS Martin Australia Pty Ltd.

Sydney · Australia
Tel.: +61 2 9439 5316
australia@klsmartin.com

KLS Martin do Brasil Ltda.

São Paulo · Brazil
Tel.: +55 11 3554 2299
brazil@klsmartin.com

KLS Martin Medical (Shanghai) International Trading Co., Ltd.

Shanghai · China
Tel. +86 21 5820 6251
china@klsmartin.com

KLS Martin India Pvt Ltd.

Chennai · India
Tel. +91 44 66 442 300
india@klsmartin.com

Martin Italia S.r.l.

Milan · Italy
Tel. +39 039 605 67 31
italia@klsmartin.com

Nippon Martin K.K.

Tokyo · Japan
Tel. +81 3 3814 1431
nippon@klsmartin.com

KLS Martin SE Asia Sdn. Bhd.

Penang · Malaysia
Tel.: +604 505 7838
malaysia@klsmartin.com

Martin Nederland/Marned B.V.

Huizen · The Netherlands
Tel. +31 35 523 45 38
nederland@klsmartin.com

Gebrüder Martin GmbH & Co. KG

Moscow · Russia
Tel. +7 499 792-76-19
russia@klsmartin.com

Gebrüder Martin GmbH & Co. KG

Dubai · United Arab Emirates
Tel. +971 4 454 16 55
middleeast@klsmartin.com

KLS Martin UK Ltd.

London · United Kingdom
Tel. +44 1189 000 570
uk@klsmartin.com

KLS Martin LP

Jacksonville · Florida, USA
Tel. +1 904 641 77 46
usa@klsmartin.com

Gebrüder Martin GmbH & Co. KG

A company of the KLS Martin Group

KLS Martin Platz 1 · 78532 Tuttlingen · Germany
P.O. Box 60 · 78501 Tuttlingen · Germany
Tel. +49 7461 706-0 · Fax +49 7461 706-193
info@klsmartin.com · www.klsmartin.com

